

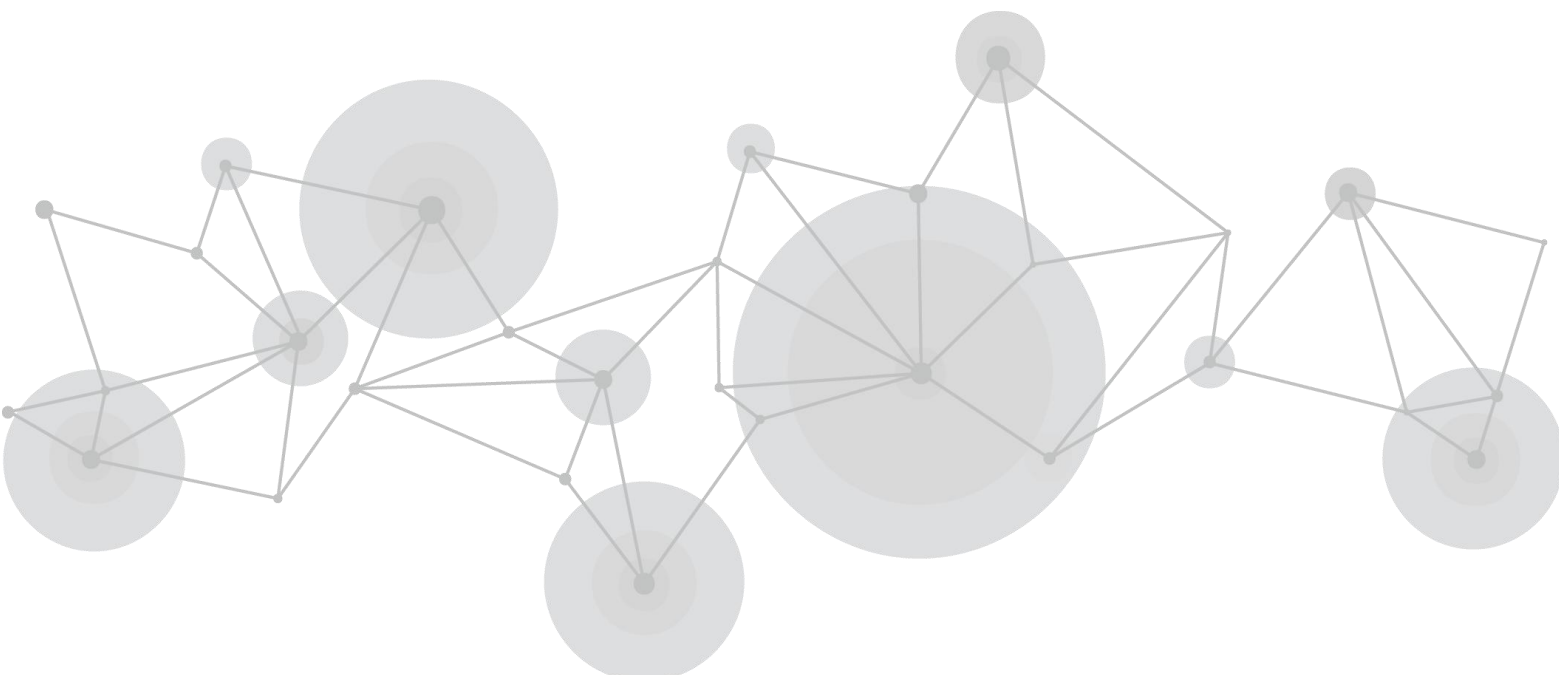

mini-pro v3

Streaming Switcher



Quick Start

目录

Product Overview	2
Key Features	2
Front Panel	3
Interface Panel	4
Installing mini-pro	5
Using mini-pro	7
MENU Introduction	7
PIP	7
Controlling PTZ Cameras	9
Saving Views	10
Loading and Switching Views	10
Audio	12

Product Overview

Key Features

- mini and is convenient to carry
- Built-in LCD for video preview and touch menu operation
- Quad HDMI 2.0 inputs (HDCP compliance), resolutions up to 4K@60
- Dual HDMI 1.3 outputs for monitoring of multi-view Preview, Program or AUX
- Mix for 4-channel HDMI embedded and 2-channel external audio
- AUTO and WIPE Switch mode available
- 15 transition effects
- USB 2.0 one-key recording in exFAT or FAT32 format with up to 16Mbps
- USB output supports YUY2 format, which can be recognized as webcam for streaming
- Support RTMP(S) network streaming up to 2 platforms
- 5-direction joystick and toggle for controlling PTZ camera (IP VISCA Protocol supported)
- Specify either "green" or "blue" as the key color for Chroma Key
- Support app control, compatible with mobile devices and desktop

Front Panel

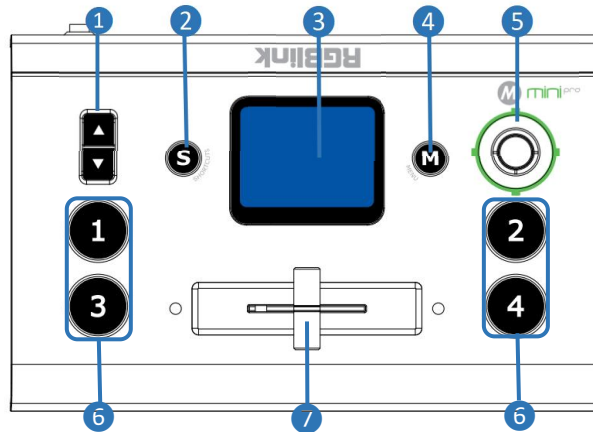

No.	Item	Description
1	Toggle	<ul style="list-style-type: none"> ● Preset Menu: Adjust Program volume. ● PIP Mode: Proportionally adjust size of sub-picture. ● PTZ Control: Zoom in and zoom out. ● IP Setting: Adjust IP values.
2	S Button	Press shortcut button to enter quick operation interface, which includes 8 Presets to load, Audio, Record on/off, Stream on/off.
3	Touch Screen	<ul style="list-style-type: none"> ● For menu operation and 4 inputs monitoring. ● PTZ Control: Monitor the screen of the currently controlled camera, and save the currently set screen by tapping it, and a call button can be formed.
4	M Button	<ul style="list-style-type: none"> ● Single Click <ul style="list-style-type: none"> ○ 4-window Monitoring Interface: Press to enter Menu Interface. ○ Menu Interface: Press to enter 4-window Monitoring Interface. ○ Others: Press to exit. ● Long Press <ul style="list-style-type: none"> ○ 4-window Monitoring Interface: Press to lock control panel. ○ Others: Press to 4-window Monitoring Interface.
5	5-Direction Joystick	<ul style="list-style-type: none"> ● Move Up/Down/Left/Right <ul style="list-style-type: none"> ○ Menu Interface: Move the cursor for item selection. ○ PTZ Control: Set pan, tilt and zoom for PTZ camera. ○ Layer Adjustment: Position adjustment for sub-layer. ● Short Press <ul style="list-style-type: none"> ○ To enter the next higher level of menu. ○ PTZ Control: Control left, right, up and down movement of camera. ○ Others: To enter PTZ Control Interface.
6	①②③④	<ul style="list-style-type: none"> ● Button Unlit: no input signal. ● Button Lit White: unselected input signal. ● Button Blinked Green: Preview out. ● Button Lit Red: Program out.
7	T-Bar	Preview and Program views can be transitioned by pushing T-Bar.

Interface Panel

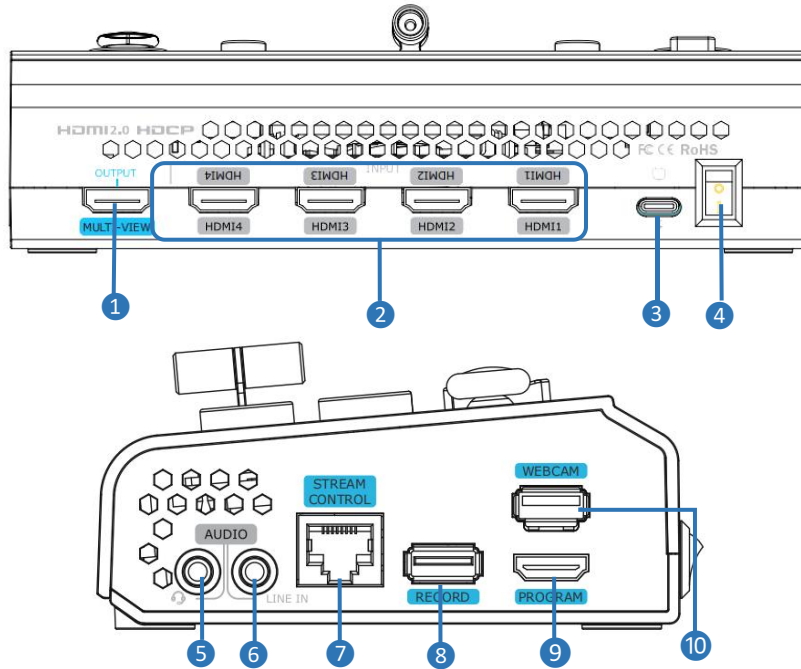

No.	Item	Description
①	MULTI-VIEW Output	Default as multi-view output, can set as Program, HDMI 1~4 or AUX output.
②	HDMI 1~4 Inputs	<ul style="list-style-type: none"> • Four HDMI input channels for connecting HDMI sources. • 4K resolution and downward compatible with all resolution.
③	USB-C Power Socket	PD protocol, 12V/1.5A.
④	Power Switch	Rocker switch to power on or off the device.
⑤	MIC In & Audio Out	Support one passive MIC input and one audio output via 2-in-1 audio split cable.
⑥	Line In	Active audio input, connect to mobile phone, computer or audio console.
⑦	Ethernet Port	<ul style="list-style-type: none"> • Control: Connected to PTZ camera for direct control. • Stream: Access to internet for live streaming. • APP: Connect to the same ethernet range of PC, tablets, and smartphones for APP control.
⑧	RECORD	Connect to SSD or U disk to record audio & video from Program.
⑨	PROGRAM Output	Default to output real-time scene, which can be set as Multi-view Preview or Test Pattern.
⑩	WEBCAM	USB Stream Output: Capture signal via third party streaming software and push to live broadcasting websites.

Installing mini-pro



Connecting HDMI Input

Connect PC, laptop, camera or DVD to mini-pro' s HDMI IN port via HDMI cable.

Connecting HDMI Output

Use HDMI cables to connect MULTI-VIEW and PROGRAM output ports to a monitor with an HDMI input port so as to check Preview and Program views in real time.



Connecting Microphone and External Monitoring Devices

Connect the microphone to mini-pro' s Audio IN port and connect the speaker or earphone to Audio OUT port.

Connecting USB for Streaming

Connect the laptop to mini-pro' s USB 3.0 port labeled as WEBCAM via USB cable, and mini-pro will be captured as a webcam source.





Connecting LAN for Streaming

Use the LAN port, users can perform live streaming directly to the live platform.

Connecting a USB Storage Device

mini-pro supports recording streaming media content to an external USB storage device, such as U disk or SSD through the USB port labeled as WEBCAM.

 **Tips:** Format SSD, U-disk before recording.



Plugging in Power

Connect mini-pro to power plug by the link cable.

Turning on mini-pro

Push the power switch on the rear panel, the device will show mini-pro logo and then enter the operation interface.



Using mini-pro

MENU Introduction



How to Enter MENU

Push 【M】 Button and the 2-inch LCD screen will enter MENU Interface.

MENU Introduction

Tap icon to enter the corresponding function management interface. Swiping from right to left to switch MENU interface.

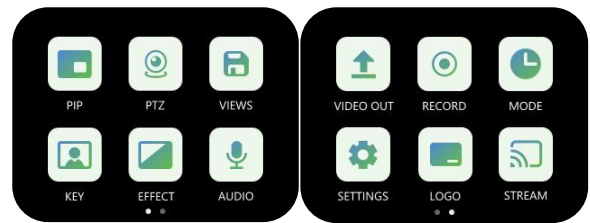

PIP



How to Enter PIP

Press 【M】 Button to enter MENU. Tap 【PIP】 icon for picture-in-picture configuration.

Selecting PIP Layout

Tap 【PIP】 icon for picture-in-picture configuration. Tap 【Layout Preset】 . PIP offers 10 layout options, select one you need.

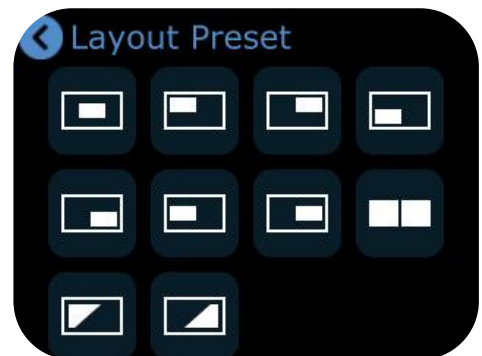

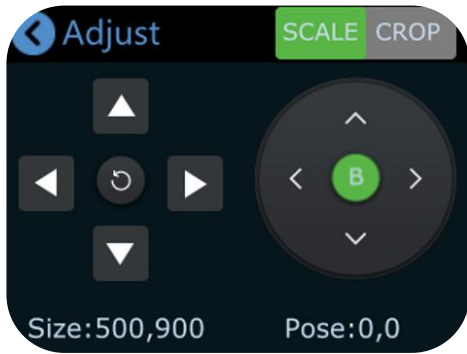

Adjusting Size and Position

Complete signal selection, then the user can do cropping and scaling by tapping  icon or using toggle on the control panel. Use the joystick to quickly adjust the position.



Using Chroma Key

Press **[M]** Button to enter MENU. Tap **[KEY]** to enter the Chroma Key interface.

Enable the function and select the background color.

[S] Button can be used to shift options between Max, Min and Margin, then you can make detailed adjustments by tapping " - " and " + " or using the toggle.

Selecting PIP Layer

Press **[M]** Button to return to PIP interface, tap **[Adjust]** for detailed adjustment.

Tap A or B or press the joystick to select main/sub-layer, then press ① ② ③ ④ input buttons to choose input signal.



Setting Blending Effect

Back to PIP interface, tap **[Blend]** , and you can enable this function to blend two input signals with a softening effect around their edges.



Controlling PTZ Cameras

How to Enter PTZ

Press **[M]** Button to enter MENU. Tap **[PTZ]** to enter the PTZ control interface.

mini-pro supports simultaneous control of up to four cameras. Tap " - " and " + " to set PTZ number, press ①②③④ button to select PTZ signal to preview.

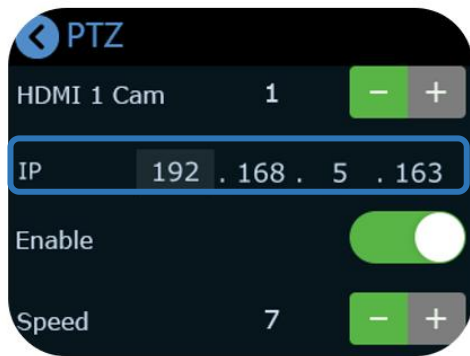

Setting IP Address

The IP address of mini-pro and camera controlled should be in the same LAN.

Use **[S]** Button to choose 4 segments one-by-one and then adjust IP address via toggle on the front panel

Adjusting Parameters

Adjust focus, position and speed to meet needs.

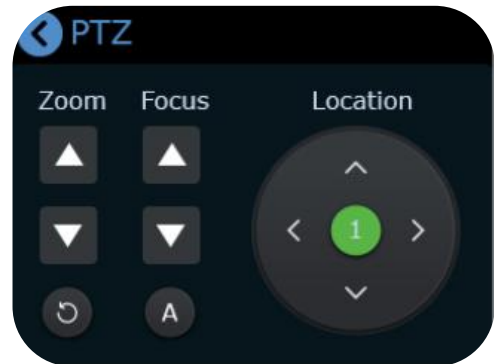

Using Toggle and Joystick

The user can use joystick to adjust rotation angle of the PTZ and toggle to adjust the focal length.



Saving Views

How to Enter View Interface

Press **【M】** Button to enter MENU. Tap **【VIEWS】** to enter the interface.

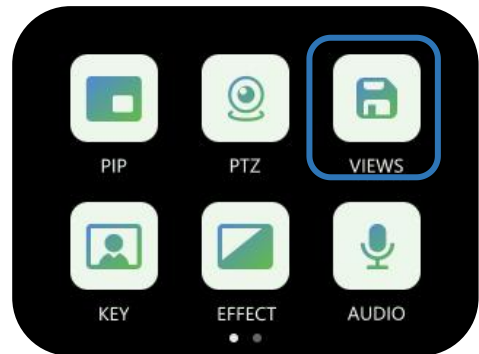

Saving Views

mini-pro allows user to save 8 presets in total to the corresponding VIEW1~8.

- Yellow: view being loaded
- Green: view contained
- Grey: blank view

Loading and Switching Views

How to Enter Shortcut Menu

Push **【S】** Button to gain quick access to the Shortcut Menu.

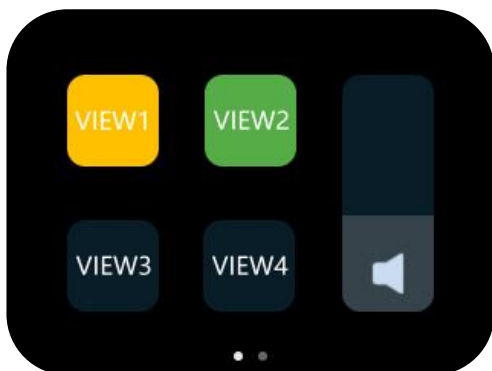

Loading Views

Tap one view needed to be loaded for fast recall.

Selecting Transition Effect

Press 【M】 Button to enter MENU. Tap 【EFFECT】 to enter the interface.

15 transition effects available.



Selecting Switching Mode

Press 【M】 Button to enter MENU. Tap 【MODE】 to enter the interface.

mini-pro provides FAST Mode and T-Bar Mode. Choose the mode and customize time by tapping " - " and " + " or using slide bar.

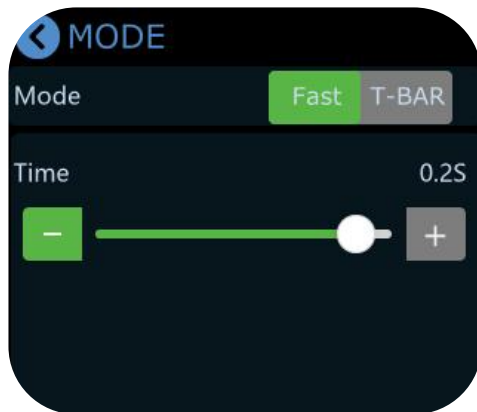

T-Bar Mode

Preview and Program views can be transitioned by pushing T-bar.



FAST Mode

Push ①②③④ signal buttons, 4 input signals can be switched in fast mode.

Audio

Default Configuration

Press **[M]** Button to enter MENU. Tap **[AUDIO]** to enter audio setting interface.

Use the slide bar to directly change the output volume. Tap MIC, LINE, HDMI 1, HDMI 2, HDMI 3, HDMI 4 to make detailed settings.

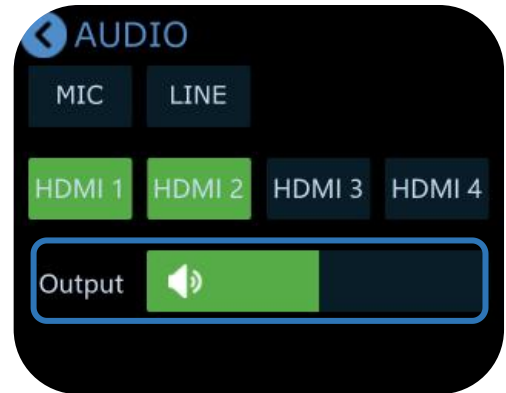

MIC in and LINE in

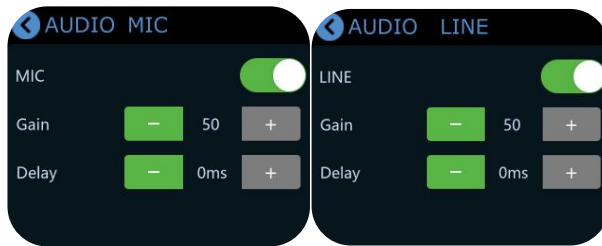

mini-pro has six separate inputs for connecting various devices and audio sources:

mini-pro features one MIC input and one LINE input. Enter **[MIC]** or **[LINE]** interface to turn on or off MIC/LINE. Tap " - " and " + " to adjust the audio volume level and set delay value.

HDMI in

Four HDMI inputs all support audio mixing and embedded audio volume adjustment. Each channel of the 4 HDMI embedded audios can be set to AFV (Audio-Follow-Video) mode.

Tap HDMI 1/HDMI 2/HDMI 3/HDMI 4 to make more detailed audio configuration. Tap " - " and " + " to adjust the audio volume level for each HDMI channel and set delay value.

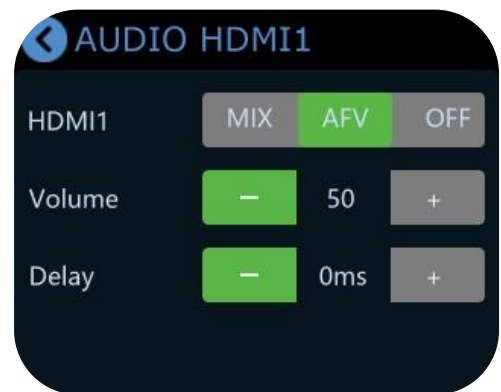



mini pro



Xiamen RGBlink Science & Technology Co Ltd.

- **Tel:** +86-592-5771197
- **Fax:** +86-592-5788216
- **Customer Hotline:** 4008-592-315
- **Web:** <http://www.rgblink.com>
- **E-mail:** support@rgblink.com
- **Headquarter:** Room 601A, No. 37-3 Banshang community, Building 3, Xinke Plaza, Torch Hi-Tech Industrial Development Zone, Xiamen, China