

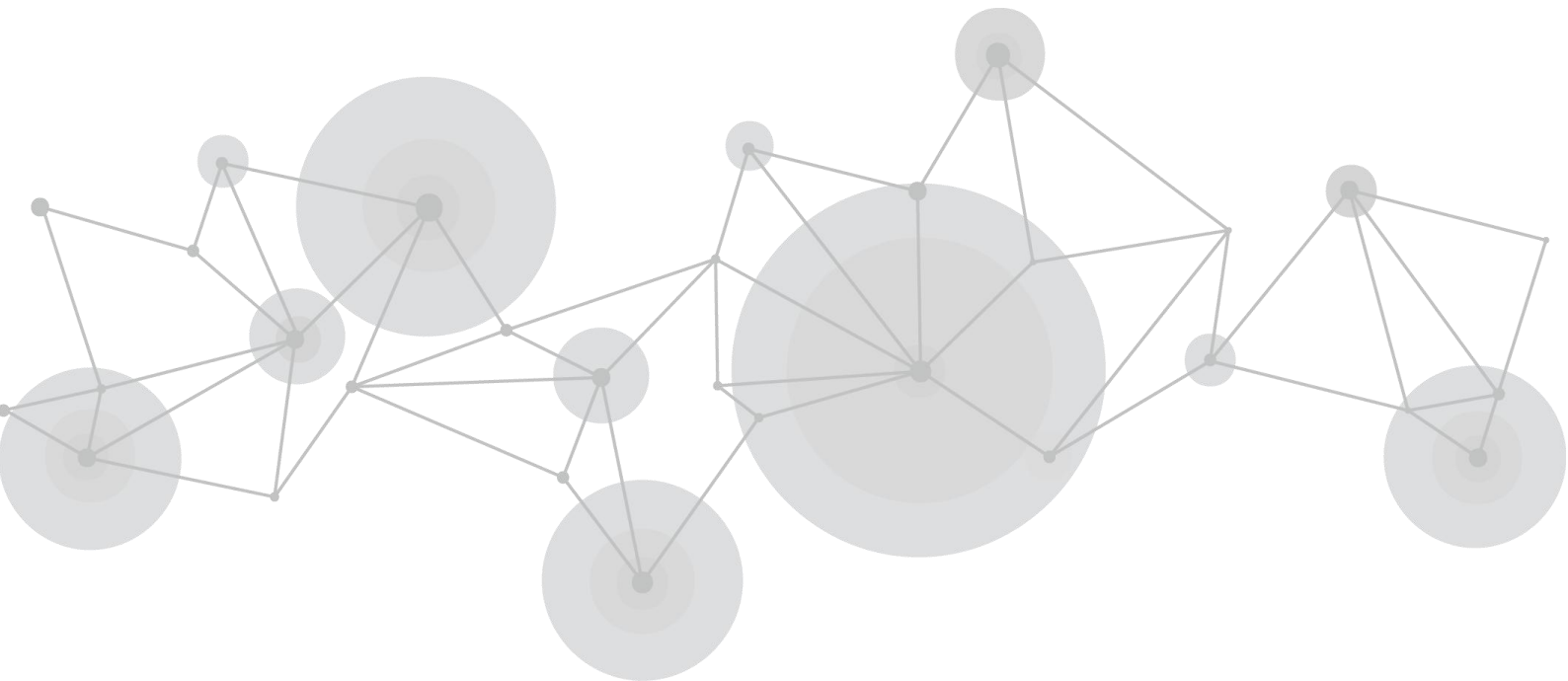

User Manual



Content

Declarations.....	3
FCC/Warranty.....	3
Operators Safety Summary.....	4
Installation Safety Summary.....	4
Chapter 1 Your Product	6
1.1 In the Box.....	6
1.2 Product Overview.....	7
1.3 Dimension.....	10
Chapter 2 Install Your Product.....	11
2.1 Plug in Power.....	11
2.2 Turn on Your mini+.....	11
2.3 Connect HDMI Input.....	11
2.4 Connect HDMI Output.....	12
2.5 Connect Microphone and External Monitoring Devices.....	13
2.6 Connect USB as a Network Signal Source.....	13
2.7 Connect Computer and mini+.....	14
Chapter 3 Use Your Product.....	15
3.1 Menu.....	15
3.2 S Button.....	19
3.3 Switch Source.....	23
Chapter 4 Streaming.....	24
4.1 OBS Streaming.....	24
4.2 vMix Streaming.....	27
Chapter 5 XPOSE mini Operation.....	29
5.1 Connect mini+ and computer.....	29
5.2 Using XPOSE mini.....	32
5.3 Upgrade.....	41
Chapter 6 Ordering Codes.....	44
6.1 Product Code.....	44
Chapter 7 Support.....	45
7.1 Contact US.....	45
Chapter 8 Appendix.....	46
8.1 Specification.....	46
8.2 Terms & Definitions.....	47
8.3 Revision History.....	53

Thank you for choosing our product!

This User Manual is designed to show you how to use this video processor quickly and make use of all the features. Please read all directions and instructions carefully before using this product.

Declarations

FCC/Warranty

Federal Communications Commission (FCC) Statement

This equipment has been tested and found to comply with the limits for a class A digital device, pursuant to Part 15 of the FCC rules. These limits are designed to provide reasonable protection against harmful interference when the equipment is operated in a commercial environment. This equipment generates, uses, and can radiate radio frequency energy and, if not installed and used in accordance with the instruction manual, may cause harmful interference to radio communications. Operation of this equipment in a residential area may cause harmful interference, in which case the user will be responsible for correcting any interference.

Guarantee and Compensation

RGBlink provides a guarantee relating to perfect manufacturing as part of the legally stipulated terms of guarantee. On receipt, the purchaser must immediately inspect all delivered goods for damage incurred during transport, as well as for material and manufacturing faults. RGBlink must be informed immediately in writing of any complains.

The period of guarantee begins on the date of transfer of risks, in the case of special systems and software on the date of commissioning, at latest 30 days after the transfer of risks. In the event of justified notice of compliant, RGBlink can repair the fault or provide a replacement at its own discretion within an appropriate period. If this measure proves to be impossible or unsuccessful, the purchaser can demand a reduction in the purchase price or cancellation of the contract. All other claims, in particular those relating to compensation for direct or indirect damage, and also damage attributed to the operation of software as well as to other service provided by RGBlink, being a component of the system or independent service, will be deemed invalid provided the damage is not proven to be attributed to the absence of properties guaranteed in writing or due to the intent or gross negligence or part of RGBlink.

If the purchaser or a third party carries out modifications or repairs on goods delivered by RGBlink, or if the goods are handled incorrectly, in particular if the systems are commissioned operated incorrectly or if, after the transfer of risks, the goods are subject to influences not agreed upon in the contract, all guarantee claims of the purchaser will be rendered invalid. Not included in the guarantee coverage are system failures which are attributed to programs or special electronic circuitry provided by the purchaser, e.g. interfaces. Normal wear as well as normal maintenance are not subject to the guarantee provided by RGBlink either.

The environmental conditions as well as the servicing and maintenance regulations specified in

this manual must be complied with by the customer.

Operators Safety Summary

The general safety information in this summary is for operating personnel.

Do Not Remove Covers or Panels

There are no user-serviceable parts within the unit. Removal of the top cover will expose dangerous voltages. To avoid personal injury, do not remove the top cover. Do not operate the unit without the cover installed.

Power Source

This product is intended to operate from a power source that will not apply more than 230 volts rms between the supply conductors or between both supply conductor and ground. A protective ground connection by way of grounding conductor in the power cord is essential for safe operation.

Grounding the Product

This product is grounded through the grounding conductor of the power cord. To avoid electrical shock, plug the power cord into a properly wired receptacle before connecting to the product input or output terminals. A protective-ground connection by way of the grounding conductor in the power cord is essential for safe operation.

Use the Proper Power Cord

Use only the power cord and connector specified for your product. Use only a power cord that is in good condition. Refer cord and connector changes to qualified service personnel.

Use the Proper Fuse

To avoid fire hazard, use only the fuse having identical type, voltage rating, and current rating characteristics. Refer fuse replacement to qualified service personnel.

Do Not Operate in Explosive Atmospheres

To avoid explosion, do not operate this product in an explosive atmosphere.

Installation Safety Summary

Safety Precautions

For all product installation procedures, please observe the following important safety and handling rules to avoid damage to yourself and the equipment.

To protect users from electric shock, ensure that the chassis connects to earth via the ground wire provided in the AC power Cord.

The AC Socket-outlet should be installed near the equipment and be easily accessible.

Unpacking and Inspection

Before opening product shipping box, inspect it for damage. If you find any damage, notify the shipping carrier immediately for all claims adjustments. As you open the box, compare its contents against the packing slip. If you find any shortages, contact your sales representative. Once you have removed all the components from their packaging and checked that all the listed components are present, visually inspect the system to ensure there was no damage during shipping. If there is damage, notify the shipping carrier immediately for all claims adjustments.

Site Preparation

The environment in which you install your product should be clean, properly lit, free from static, and have adequate power, ventilation, and space for all components.

Chapter 1 Your Product

1.1 In the Box

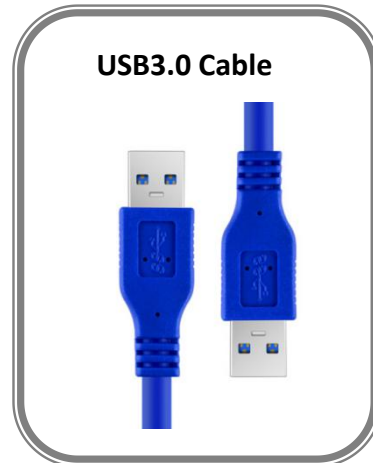

Note:

Power Adapter supplied as standard according to destination market.

For computers/phones/pads without HDMI port but with Type C interface, you can convert Type C to HDMI. Be sure that the Type C interface shall meet the USB 3.1 standard.

1.2 Product Overview

mini+, as a pocket-sized push-stream switcher, supports real-time monitoring, special effects switching, live streaming, audio insertion, independent input format conversion, PTZ camera control based on VISCA protocol, Chroma key, LOGO overlay and other functions. mini+ is able to control 8 PTZ cameras at the same time and do operations of Zoom In/Out. Meanwhile, mini+ also supports not only Window and MAC operating systems, but also ISO and Android mobile phones for a wide range of fast operation.



1.2.1 Key Features

- USB3.0 live streaming Port
- 4CH HDMI inputs
- 2" TFT display on board to Live preview four inputs
- Auto cut and manual switch (T-Bar)
- 14 transition effects on T-Bar
- Support PIP (Picture-In-Picture)
- Audio offers AFV or Line In mode.
- Support switch between 6-Picture PVW and PGM to HDMI Out
- Control by PC or mobile phone (via APP)
- Compact design
- Logo
- Chroma Key
- PTZ control

1.2.2 Front Panel

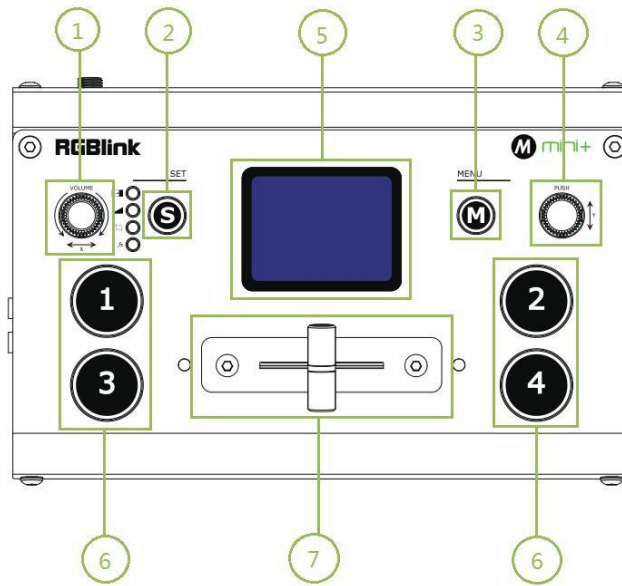

1	VOLUME/X	<ol style="list-style-type: none"> 1. Turn to adjust volume of PGM 2. Control camera left-right spinning when it is in PTZ setting
2	S	<p>Function selection button to select</p> <ol style="list-style-type: none"> 1. Transition Effect (→■), 2. Switch Mode(MODE:CUT ◀ or T-Bar), 3. PIP(□.), 4. FX(fx , enter PTZ camera setting)
3	M(menu)	Menu and back button
4	PUSH/Y	<ol style="list-style-type: none"> 1. turn knob to select menu item, push to confirm 2. Push knob to quickly switch HDMI Out between 6-Picture PVW and PGM when TFT is under the state of previewing 4 inputs 3. Turn knob to control camera lens position, moving up and down under PTZ control menu-Pos 4. Turn knob to control camera lens zoom in and out under PTZ control menu-Zoom
5	TFT display	To display 4 inputs and menu
6	1,2,3,4	<p>4 inputs,</p> <ol style="list-style-type: none"> 1. red: is on air (PGM), 2. static green: signal is standing by, 3. flashing green: ready to be switched, 4. No light: input source is not supported
7	T-Bar	Manual switch, push to left end or right end to switch signal to PGM

1.2.3 Interface Panel

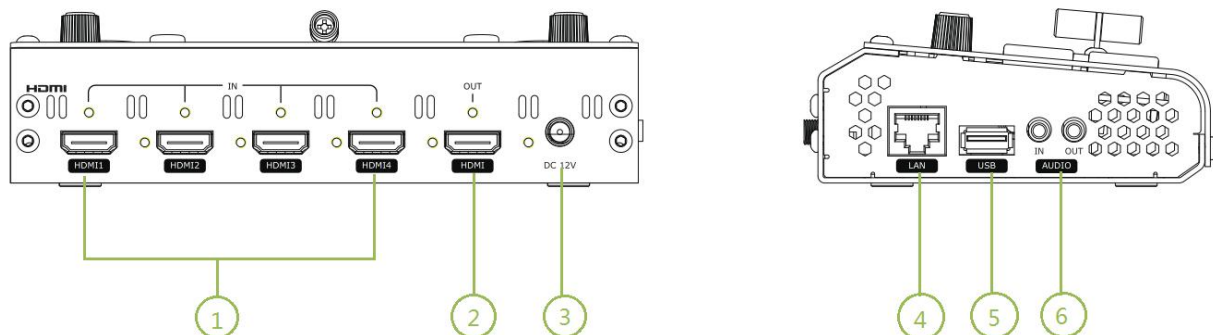

1	HDMI IN	4 HDMI Inputs, connect to input source from HD camera or PC
2	HDMI OUT	1 HDMI Output port, connect to display to show Preview (6 pictures) or PGM.
3	DC 12V	1 DC Jack for power input, connect to 12V/4A power adapter.
4	LAN	Communication port to link dedicated software for control
5	USB	USB3.0 output, capture signal via third party streaming software and push to live broadcasting websites
6	AUDIO IN/OUT	AUDIO In, analog audio input port, connect to microphone with power AUDIO OUT, analog audio output port, connect to loudspeaker

1.3 Dimension

Following is the dimension of mini+ for your reference:

180mm × 113mm × 49mm

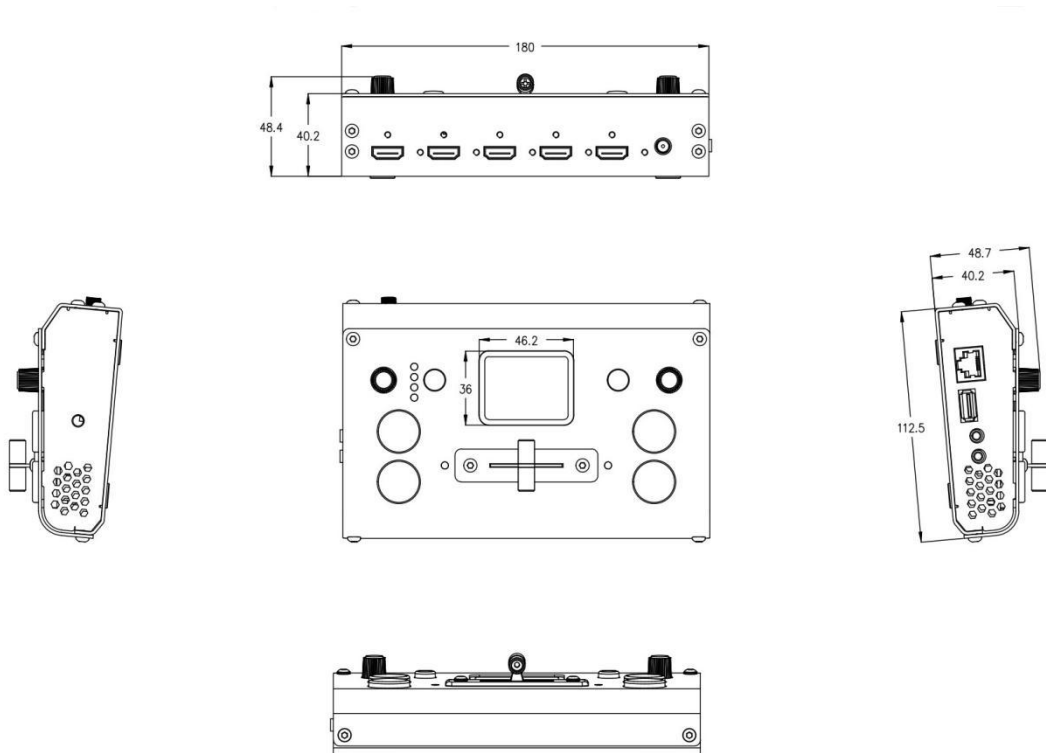

Chapter 2 Install Your Product

2.1 Plug in Power

RGBlink mini+ is packaged with a 12V power link cable and two standard power plugs for British and Australian standards.

When linking the power supply, please check the power supply standard used in your country/region. If you are using a power supply that does not have a lock, please tighten the power connector of the device to ensure the stability of the mini+'s power supply.

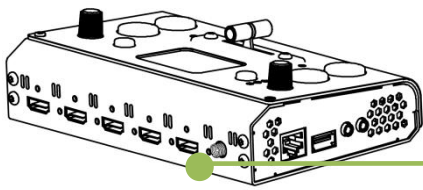

Connect mini+ to power plug by the link cable

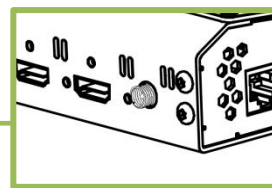

Tighten the power connector

2.2 Turn on Your mini+

The device will enter to the boot interface automatically after being powered on.



2.3 Connect HDMI Input

You can use any camera, computer or other HDMI device as the input source of the mini+. It supports up to 1080P standard and 4 sources of different formats and resolutions at the same time. If you are using interlaced signal, mini+ supports one de-interlacement to all interlaced signals. This step is automatically recognized by the mini+ and does not need to be done manually. You can see the resolution of the input signal in the mini+'s TFT screen.

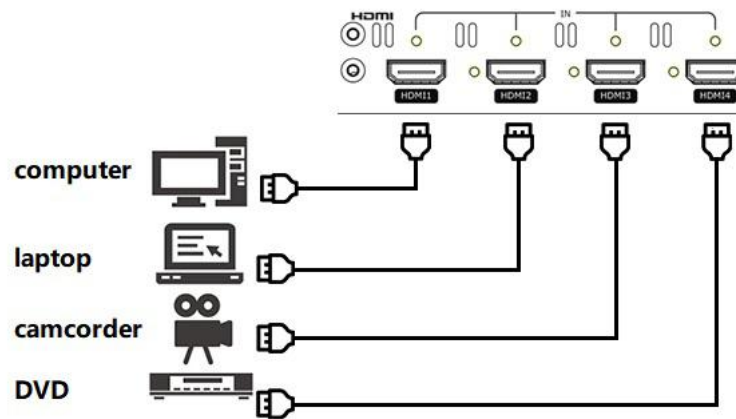

Note: The HDMI cable is not included in the mini+ package and needs to be purchased separately. Some camcorders use a mini HDMI port, you need to buy a mini HDMI-HDMI cable separately when you use these camcorders.

2.4 Connect HDMI Output

In the mini+, you can choose to use HDMI output as the pre-monitoring interface to achieve 16:9 6-picture split pre-monitoring, and we also provide a preset function.

mini+ also provides a powerful function to modify the output resolution, you can use "Y" knob and "M" button in combination to adjust the output.



Connect LCD display to mini+ by HDMI cable to display 6-picture PVW.

2.5 Connect Microphone and External Monitoring Devices

On the left side of the mini+, a standard 3.5mm microphone jack is provided. The mini+ supports the independent input of an active (self-powered) microphone device, allowing the mini+ to collect sound information more clearly when it is used for interview programs. You can also use an external sound console to mix multiple external sound inputs.

The mini+ also provides a standard 3.5mm audio output, so you can use external speakers or headphones to monitor the mini+'s main output audio signal in real time.

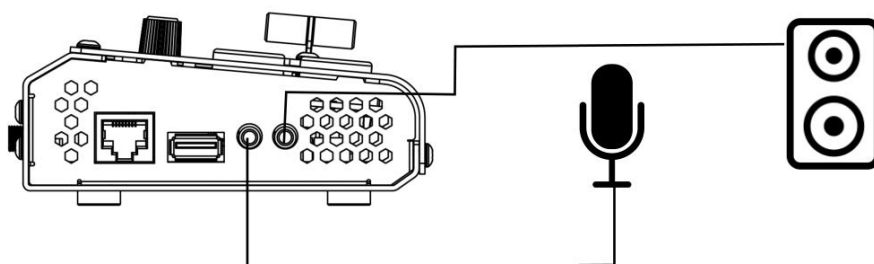

Connect microphone to Audio In and Loudspeaker to Audio Out

2.6 Connect USB as a Network Signal Source

You can use the mini+'s USB port to use the mini+ as a webcam source, and you can recognize the webcam signal from the mini+ on live streaming platforms like Zoom, YouTube, Facebook, Twitch, OBS, etc.

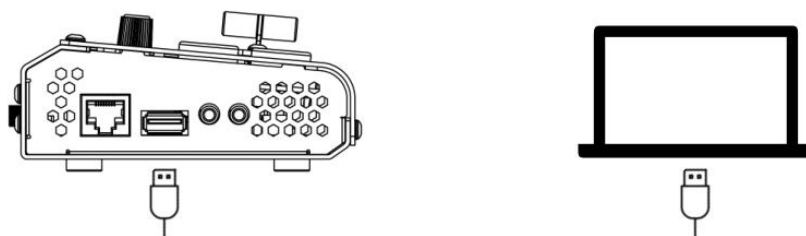

Note: If your computer only has a Type-C port, you can use a USB-A to Type-C cable to transmit the webcam signal. Please note that the Type-C cable you choose needs to support data transmission. The signal is recognized in Windows system as 「RGBLink」.

2.7 Connect Computer and mini+

Software control:connect computer and mini+ with CAT6 cable

Record and Stream:connect mini+'s USB-A and mini+'s USB 3.0 port with USB3.0 cable

(Note:the color of USB3.0 port is blue)

Minimum System Requirements for macOS

- macOS 11.0 Big Sur or later
- macOS 10.15 Catalina

Minimum System Requirements for Windows

- Microsoft Windows 10 64-bit

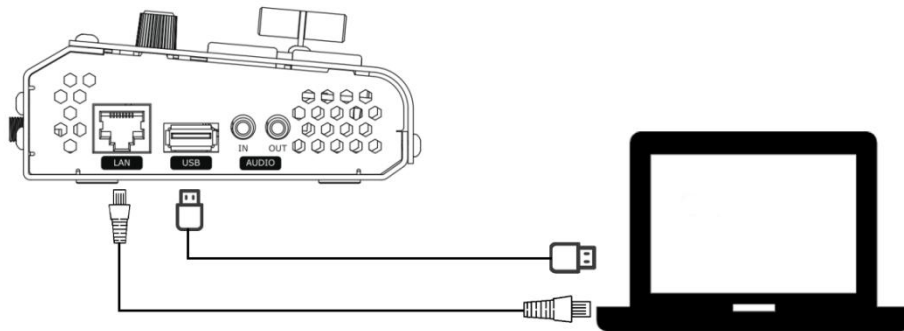

Note: The IP address of the mini+ must be in the same WLAN segment as the computer.

Chapter 3 Use Your Product

3.1 Menu

Main Menu

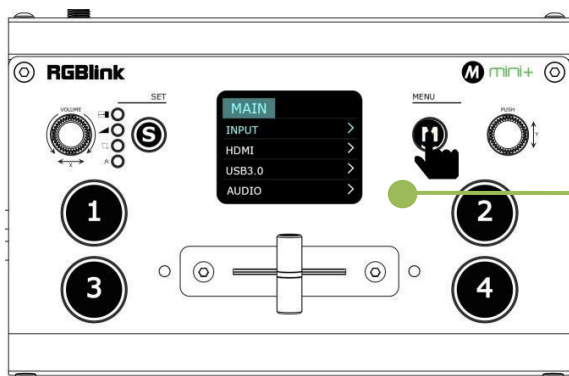

After mini+ is powered on, push button M to enter the main menu. Main Menu include:Input, HDMI, USB 3.0. Audio, Logo Overlay, Ip Setting, Language, Reset

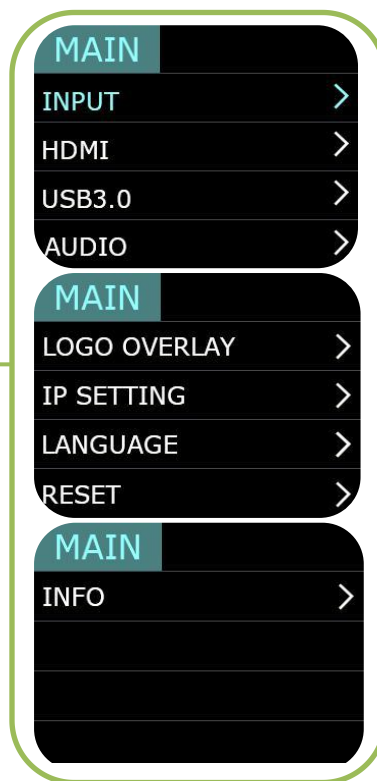

3.1.1 Input

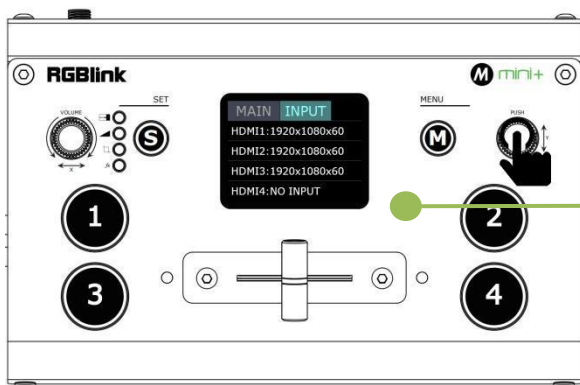

Push 「M」 button(MENU) to enter main menu and select first menu item<INPUT>,push 「Y」 knob to enter <INPUT>menu.



The input menu displays the information of the input signal source.

If there is no input source, it displays: NO INPUT.

3.1.2 HDMI

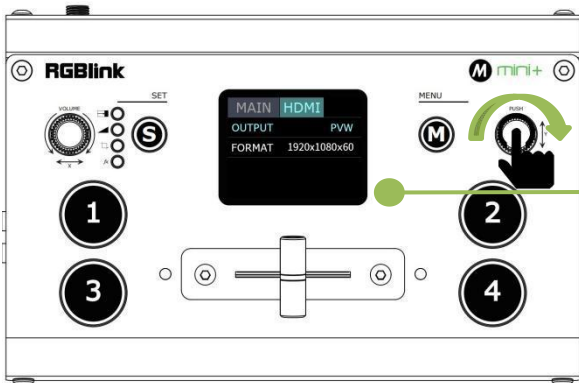

1. Push MENU and select the second menu item <HDMI>

Push 「Y」 knob to enter <HDMI> menu.

2. rotate 「Y」 knob to select PVW output and PGM output for HDMI.

Output: PVW or PGM

Format: 1920×1080@60

3.1.3 USB3.0

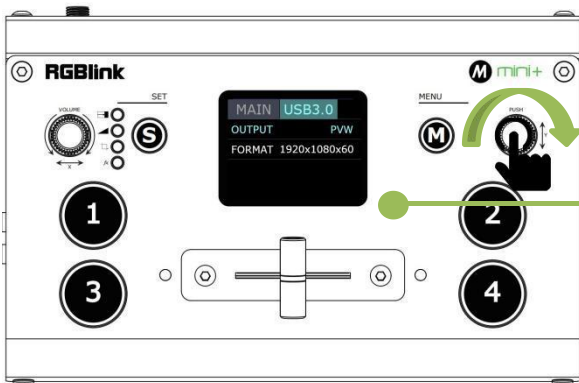

1. Push MENU, rotate and push 「Y」 knob to enter the third menu item <USB3.0>

2. rotate 「Y」 knob to select **PVW output** and **PGM output** for HDMI.

Output: Choose PGM or PVW

Format: 1920×1080@60

3.1.4 Audio

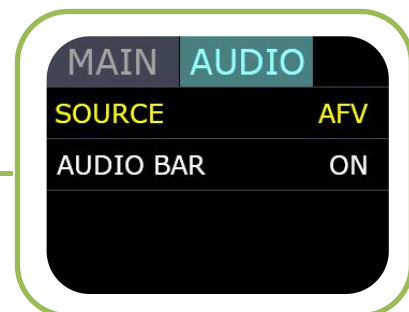
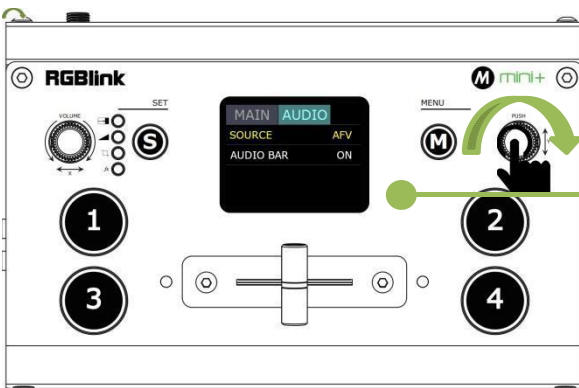

1. Push MENU, rotate and push 「Y」 knob to enter the fourth menu item <AUDIO>

2. Rotate 「Y」 knob to select
Audio Source: **AFV** or **LINE IN**
Audio Bar: **ON/OFF**

3.1.5 LOGO Overlay

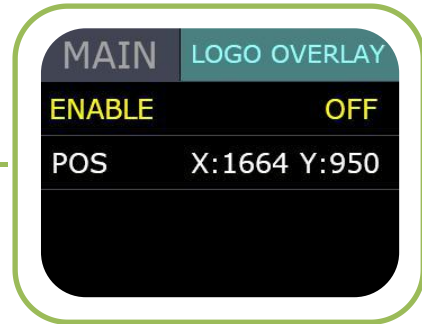
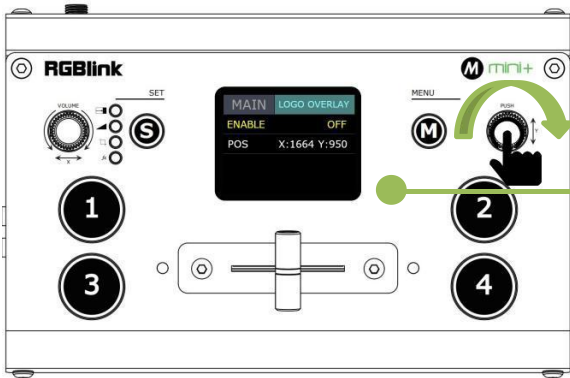

1. Push MENU, rotate and push 「Y」 knob to enter the fifth menu item<LOGO OVERLAY>

2. Rotate 「Y」 knob and select ON/OFF ENABLE and set the position of LOGO

Note : If it is your first time to use the logo overlay function, please refer to 3.4.2 Using XPOSE mini first.

3.1.6 IP Setting

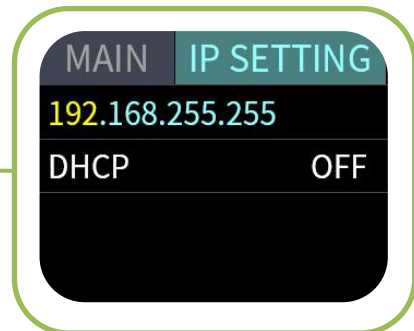
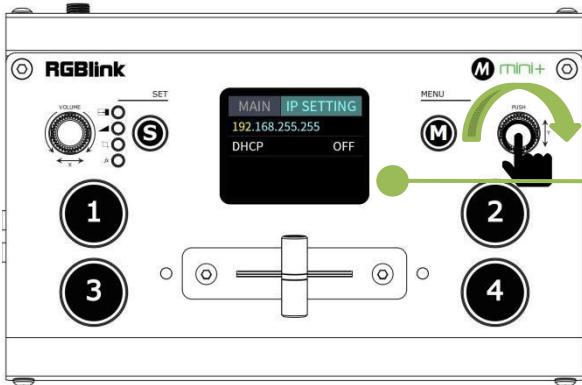

Push MENU, rotate and push 「Y」 knob to enter the sixth menu item<IP SETTING>

SET IP Address Manually

Select **each segment** with the 「Y」 knob, then press to enter and set the **value** of each segment by pressing the knob again.

Set IP Address Automatically

Use this setting if your network/router has a DHCP server

Select **DHCP** and set to **ON**, manual setting is disabled, and the IP Address for mini+ is set from the network.

Note: After setting IP address manually, please restart the device.

3.1.7 Language

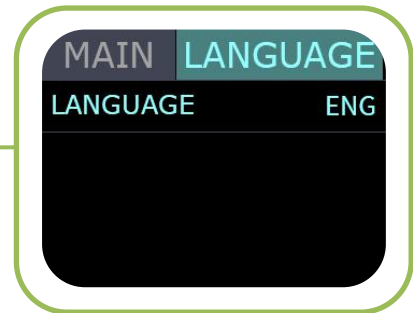
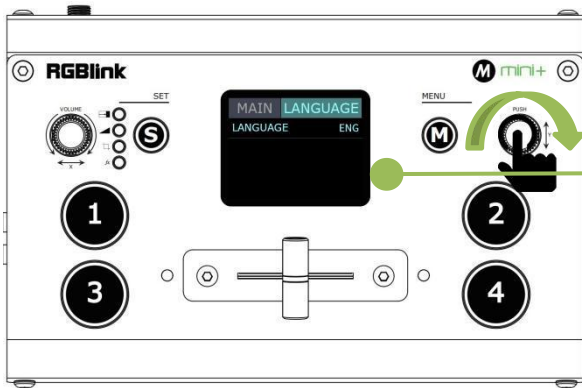

1. Push MENU and rotate and push 「Y」 knob to enter the seventh menu item<LANGUAGE>

2. Rotate and push 「Y」 knob to select Chinese and English.

3.1.8 Factory Reset

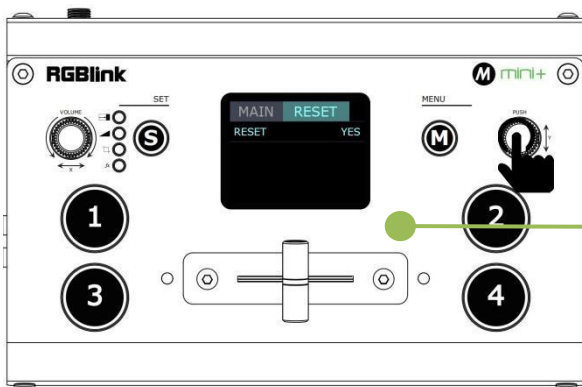

1. Push MENU and rotate and push 「Y」 knob to enter the eighth menu item<RESET>

2. Rotate and push 「Y」 knob to select YES or NO

3.1.9 INFO

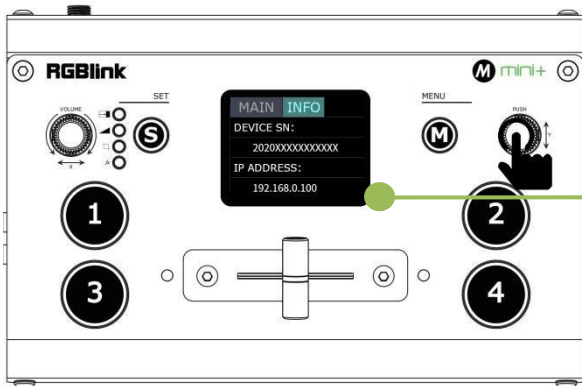

Push MENU and rotate and push 「Y」 knob to enter the ninth menu item<INFO>



INFO shows Device SN,IP address,MAC address,MAC address,MCU version,Video version.

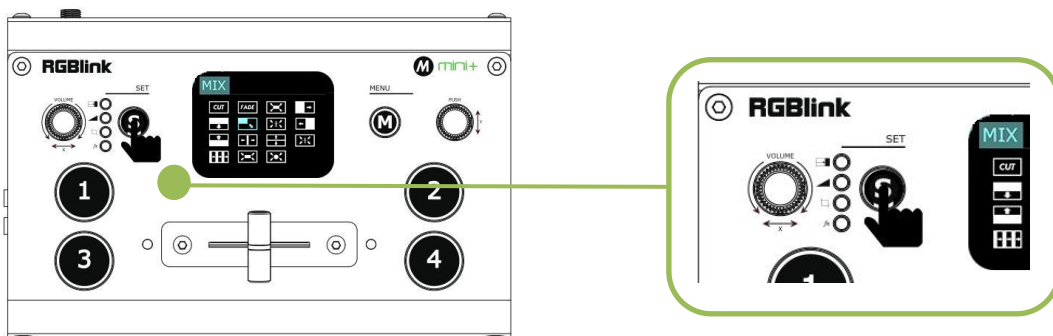

3.2 S Button

When you want to personalize your live show, you can use the mini+'s 14 built-in switching effects and control the timing of the switch via T-BAR.



1. Push S button **once** to enter mode switch menu<MODE> and the LED indicator beside  will light up
2. Push S button **twice** to enter mode switch menu<MODE> and the LED indicator beside  will light up;

3. Push S button **three times** to enter menu<PIP> and the LED indicator beside  will light up;
4. Push S button **four times** to preview 4 inputs and the LED indicator beside *fx* will light up;

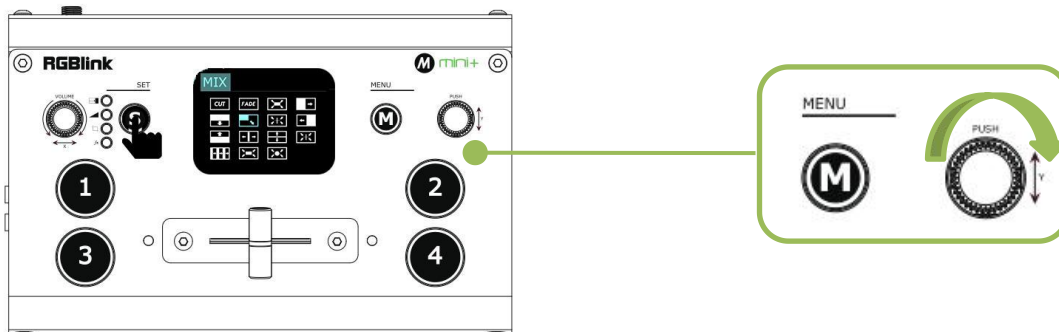

Each time the menu is opened, the corresponding indicator light will be on, and then rotate the PUSH knob (" Y ") to select and confirm.

3.2.1 MIX

Press S button to enter transition effect menu<MIX>,there are 14 kinds of effects
To change the switching effect, proceed as follows.

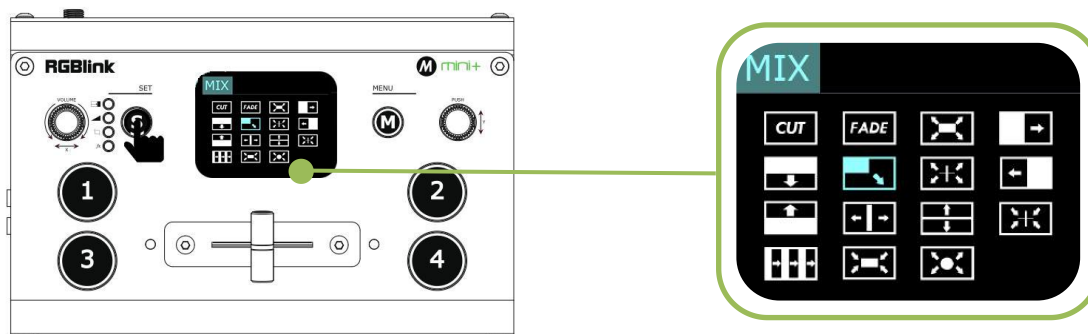

1.Push S button to enter transition effect menu<MIX>

Transition effect as picture above

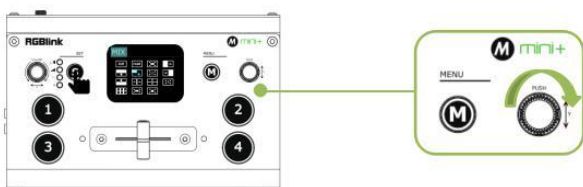

2.Turn knob Y to select transition effect

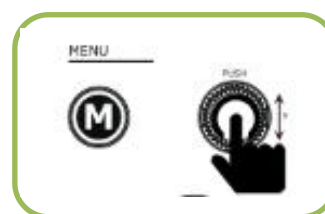

3.Press knob Y to confirm

Note : In actual use, the hard cut is only available in **Quick Cut** mode, if you use **T-Bar** mode, it will automatically change to FADE.

3.2.2 MODE

Push S button **twice** to enter <MODE>menu, and rotate 「Y」 knob to select **FAST** or **T-BAR**
After selecting Quick Cut, you need to select the switching time: from **0.5s** to **5.0s**.

The steps are as follows.

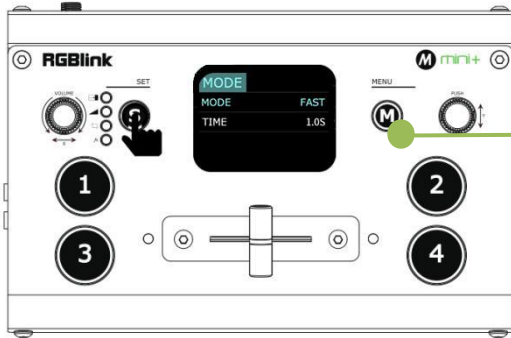

1. Press the "S" button twice to enter the mode interface.

Mode include **Fast** and **T-Bar**

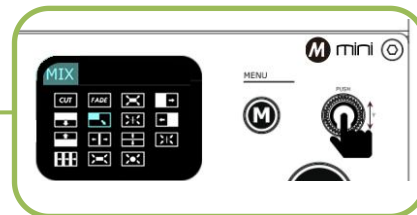
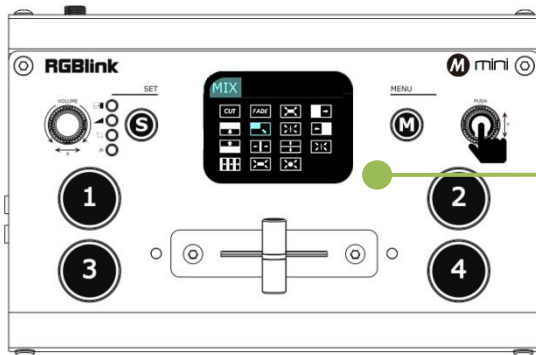

2. Press the 「Y」 knob and wait for the option to turn yellow. 3. Turn the 「Y」 knob to change the parameters.

3. Press the 「Y」 knob to confirm.

Note: In T-Bar mode, you can directly control the progress of the T-Bar manually and customize the switching.

3.2.3 PIP

Push S button three times to enter <PIP> menu and select PIP mode(9 PIP modes)The steps are as follows:

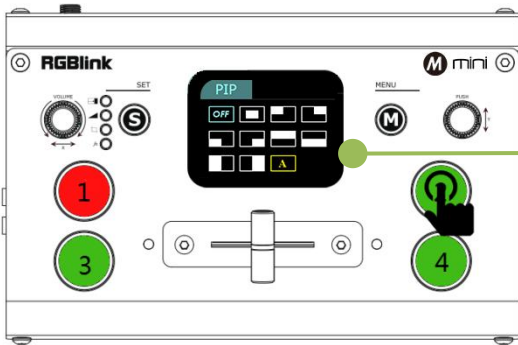

1. Select the signal you want for background. (When the letter is A, it means background signal)



2. Push "S" button three times to enter PIP setting page.



3. Rotate 「Y」 button to select layout you want and confirm by Pressing.

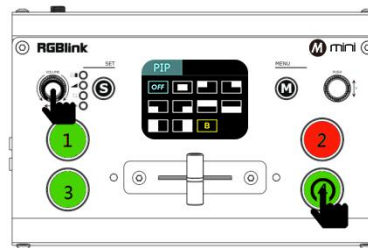

4. Push 「X」 button first and then push signal button for sub-picture, when letter is B meaning sub-picture.

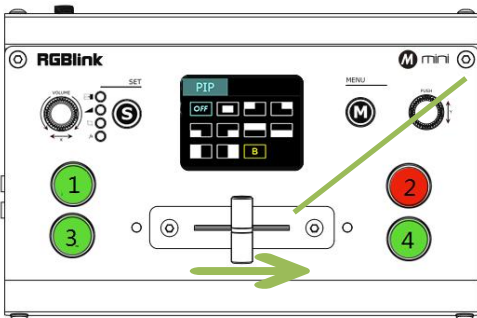

T-bar has to be totally left or right side to make sure the content has been taken

5. Finally, push the T-Bar and the content you've set will be taken to PGM.

How to Enter PIP Menu Quickly

S button has memory function. When the TFT screen returns to preview mode, press S button to directly enter PIP menu if you use it last time. If you want to enter other menus, continue to press the "S" button.

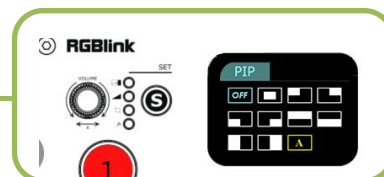
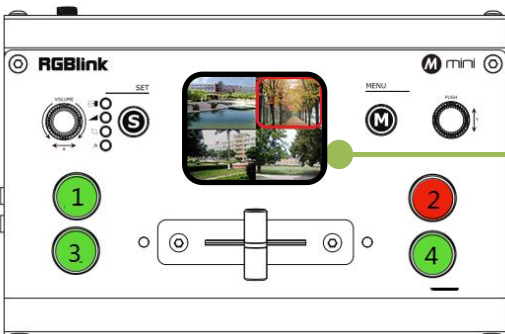

3.3 Switch Source

When you access the four source buttons, the lights on the source buttons will appear in four states:

green constant: the signal is recognized, no action is being taken;

green flashing: the currently selected, signal is being edited;

red constant: the signal is currently on the main output;

unlit: the source is not accessed or the resolution of the accessed source is not supported by the mini+

After transition effect (MIX) and transition mode (MODE) is selected

In FAST+Time Mode:

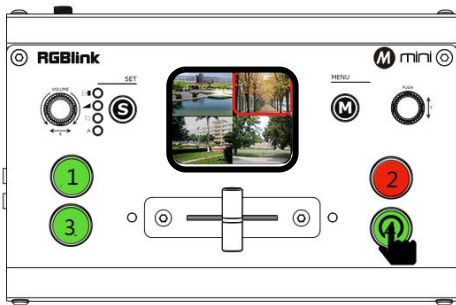

1. Press a source button (1, 2, 3, or 4) that is green.

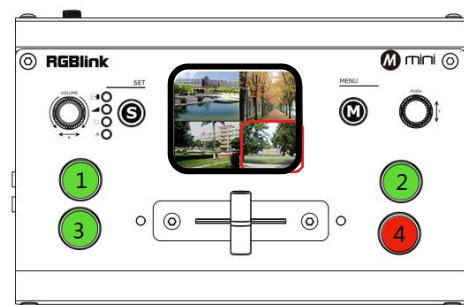

2. Selected source will be switched to the output with the set fade TIME and using the MIX transition selected, with the pressed source button becoming red.

Press a green button to set the source as the PVW, the source but

Slide the T-BAR to switch/mix from the current PGM source to the PVW source. Any MIX

transition effect will be applied as the T-BAR is moved. Once the T-BAR has been **fully** transitioned, the indicator lights on sources buttons that are PGM and PVW will be swapped.

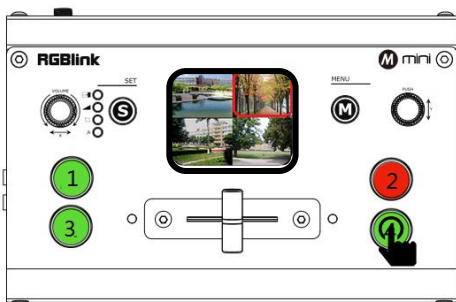

1. Press a source button (1, 2, 3, or 4) that is green.

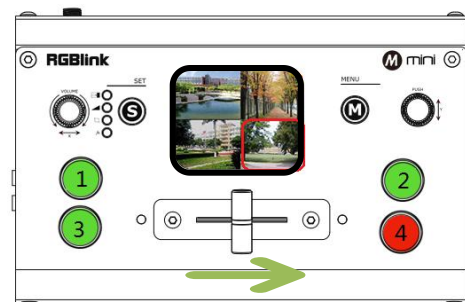

2. Slide T-Bar from left end to right end or reversely.

Note: Source selection is **locked** when T-BAR is **in transition** (not entirely docked at a left or right position)

Chapter 4 Streaming

4.1 OBS Streaming

Video Capture

mini+ is compatible with many third party steaming software, we recommend OBS, which is available to download on <https://obsproject.com/download>. Download the software and update to the latest version.

1. Click "+" icon
2. choose video capture device
3. Click video capture device to open up setting page
4. Choose :RGBlink USB 3.0 Capture
5. Choose Video Format YUY2

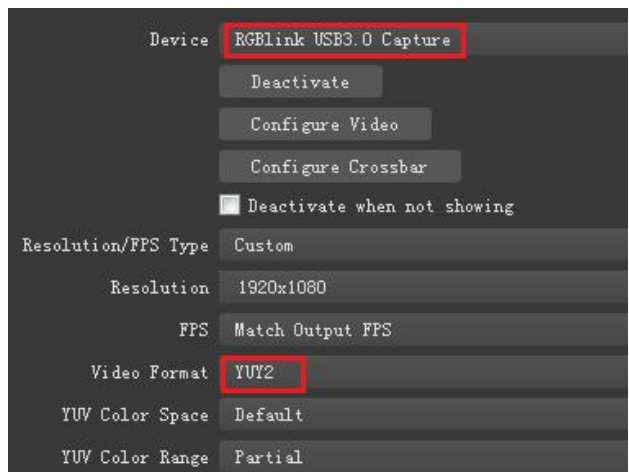
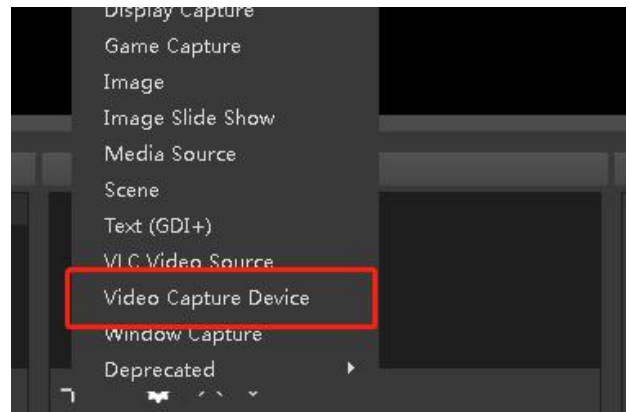
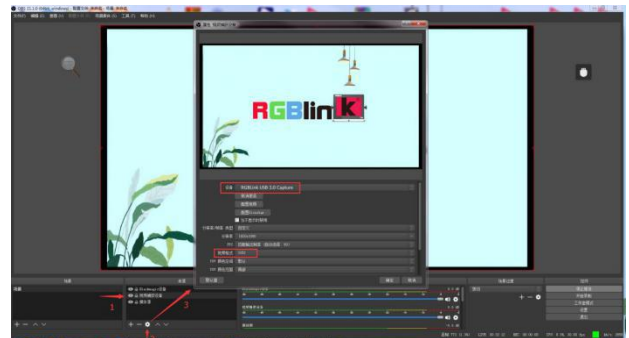

Note: If there is no video format YUY 2 after setting above, check the USB 3.0 port connection. Make sure it is linked to USB 3.0port on PC by USB 3.0 cable. (USB 3.0 cable or port is standard in blue while USB 2.0 is in black).If the captured , change the video format to YUY2.

Audio Setting

When there is no audio playing first check the video source see if the it is set in default value and then check the audio setting on OBS.

1. Set Default for the audio source.

2. Audio setting on OBS.

Choose Audio, click Setting and choose audio device (Mic/Auxiliary Audio Device)

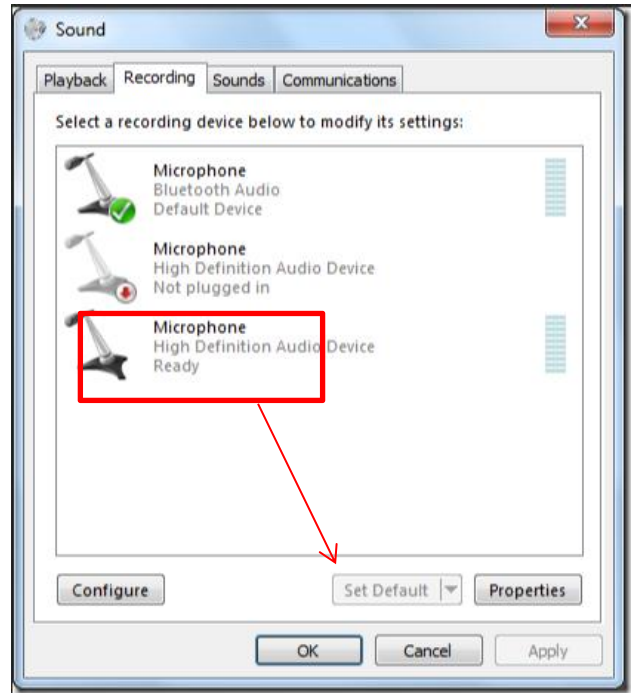

Synchronize Video with External Audio

When the video itself doesn't have embedded audio and need insert external audio. Here are the steps.

1. Set the audio source

Setting → Audio → Mic/Auxiliary Audio Devices

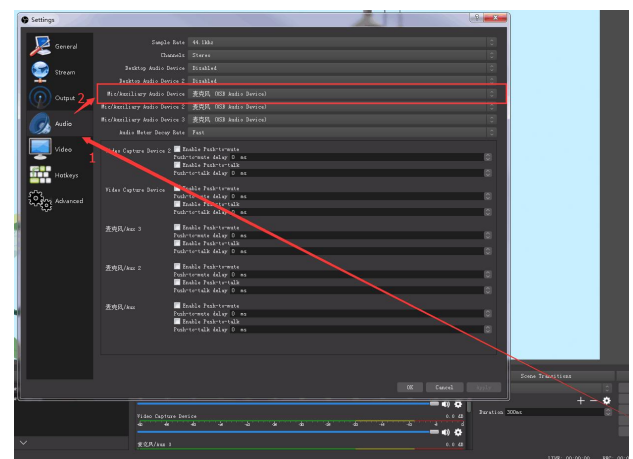

2. Right click the Video Capture Device in Source and choose Filter

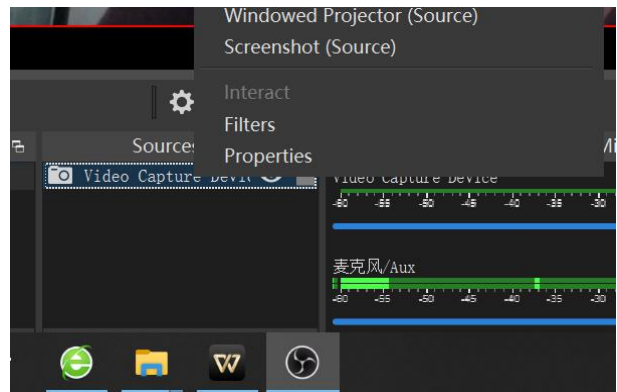

3. Click "+" under Audio/Video Filters and choose Video Delay (Async)

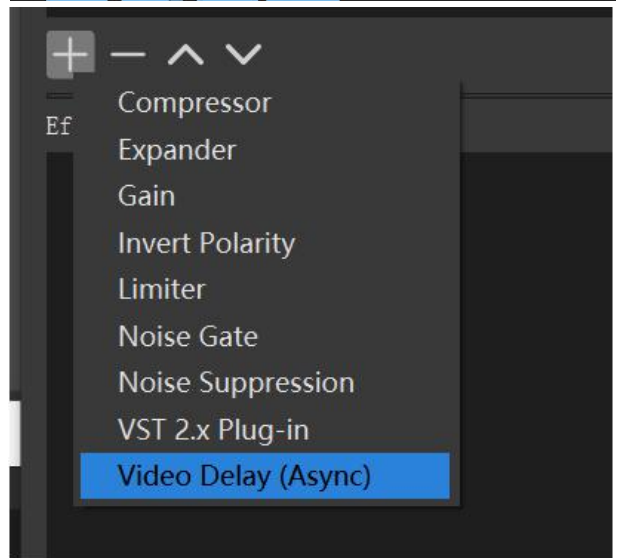

4. You can custom the filter name in the pop-up window. Click OK to confirm the filter name.

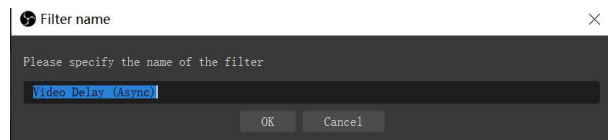

5. Input delay value in ms, the value need to adjusted until the video and audio is synchronous.



Streaming Setting

1. Find the RTMP URL and Stream Key provided by streaming broadcast website.
2. Copy URL and Stream Key
3. Back to OBS, click Setting in the lower right corner and click “Stream”. Choose Stream Type as “Streaming Service” or “Custom Streaming Server” . If choose “Streaming Service”, there is a list of streaming service name available in the drop down list of Service. If the streaming service is in the list, choose it from the list. If choose Custom Service, just fill in URL and Stream Key.
4. Paste the RMTP URL to Server or URL and Stream Key to Stream Key.
5. Click “Start Streaming”.
6. Go back to live broadcast website and check the broadcasting.

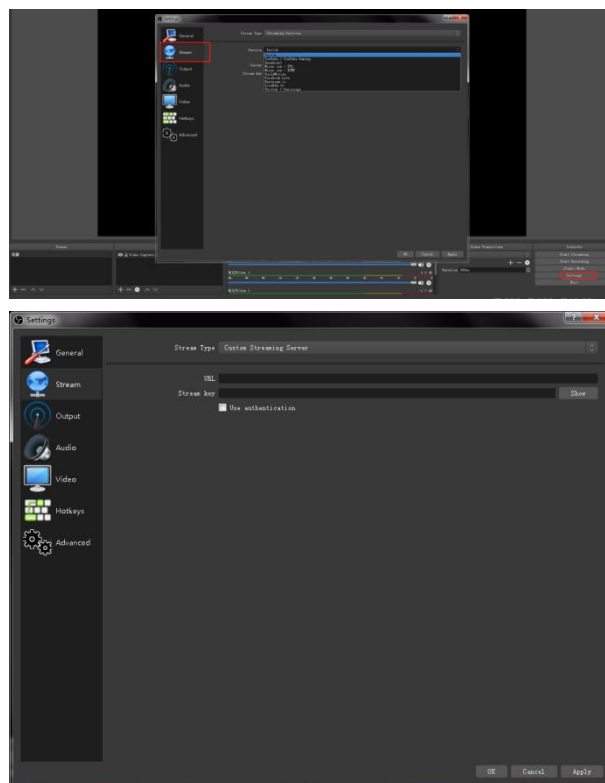

4.2 vMix Streaming

mini+ streaming via vMix steps are as follow:

1. Click a new blank, then click the “Add Input” button.

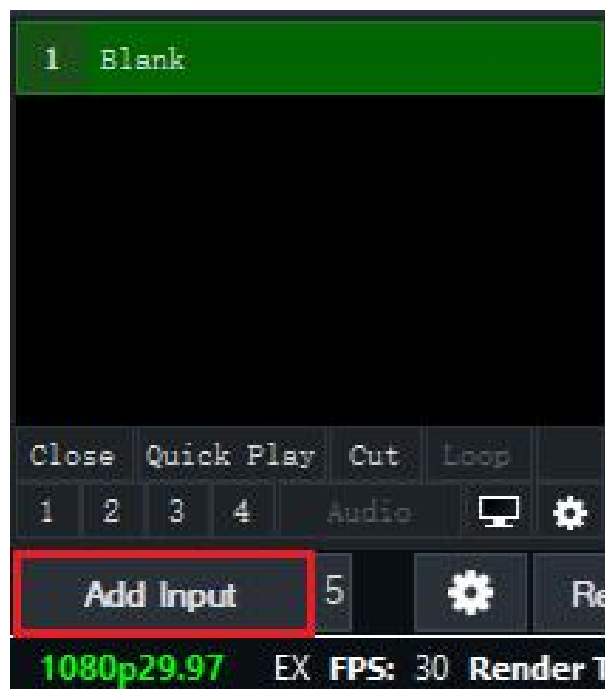

2. Select Camera-Camera-RGBlink USB3.0 Capture.

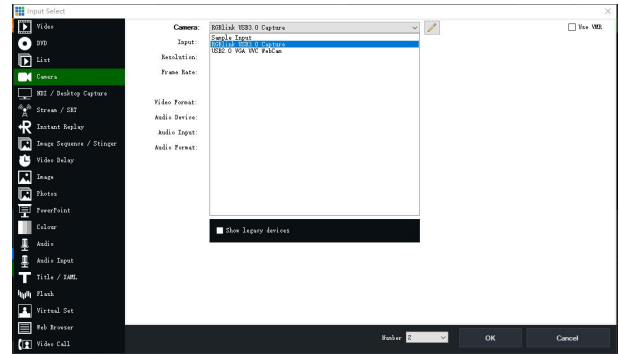

3. Select the same resolution as the mini+ output. Then click "OK".

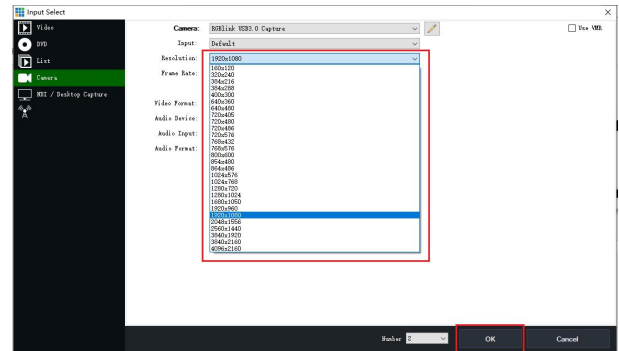

4. Click Stream setting button.

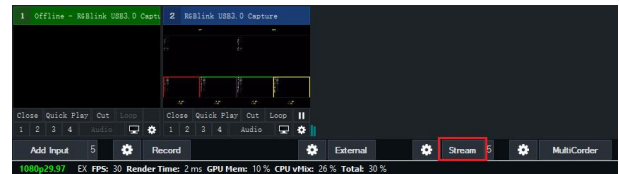

5. Complete the URL and Key information. Click "Start 1", vMix will begin streaming.

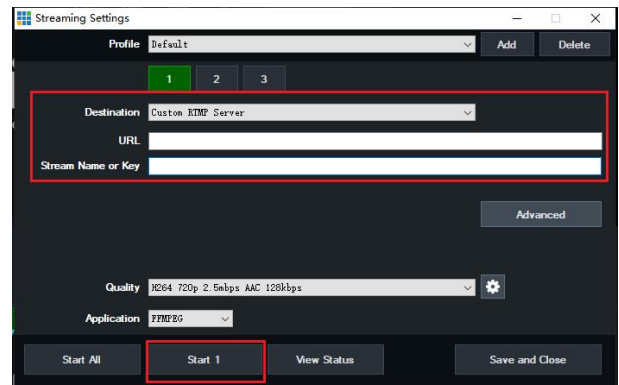

Note: vMix does not support automatic recognition of the output resolution of mini+. Every time the output resolution of mini+ is modified, the picture on vMix will pause. The user needs to re-select RGBlink USB3.0 Capture and manually input the current output resolution of mini+.

Chapter 5 XPOSE mini Operation

XPOSE mini is a software that allows you to control your mini+, RGBlink is available for all platforms including Android, iOS, MacOS, Windows.

You can either connect the mini+ directly to your computer via the LAN port provided by the mini+, or link the mini+ to your router and the computer to the Wi-Fi emitted by your wireless router.

Minimum System Requirements for macOS

- macOS 11.0 Big Sur or later
- macOS 10.15 Catalina

Minimum System Requirements for Windows

- Microsoft Windows 10 64-bit

Note:The IP address of the mini+ must be in the same WLAN segment as the computer or the mobile control device you choose.

5.1 Connect mini+ and computer

5.1.1 Direct Link via a Network Cable

(1) Modify mini+'s IP Address

The mini+ is connected to a computer via TCP/IP protocol for data transfer. Therefore, you need to keep the mini+ on the same IP network segment as your PC or mobile device. If the mini+ is connected directly to a computer, you need to change the mini+'s IP manually to avoid IP conflicts on the same network segment.

Steps to modify mini+'s IP address:

1. Push [M] button
2. Enter IP setting sub-menu
3. Push [Y] knob to enter the setting, rotate [Y] knob to change value. Press the [Y] knob one after another to confirm

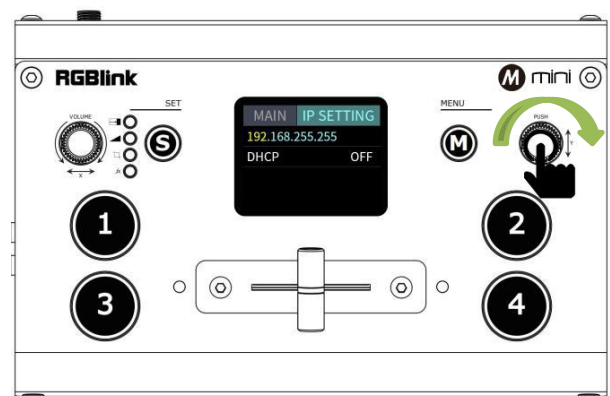

(2) Change the PC's IP Address

To ensure that the mini+ and the PC can communicate smoothly, the IP address of the computer needs to be verified.

Steps to modify the IP address of the Ethernet port (windows).

1. Open the "Network and Sharing Center";

2. Click on "Internet";

3. Access to Properties may require administrator privileges;

4. Under "This connection uses the following items", find "Internet Protocol version 4 (TCP/IPv4)";

5. Select "Use the following IP address" and change the IP address to the same network segment as mini+, eg: mini+'s IP address is 192.168.0.99, then the computer's IP address can be set to 192.168.0.1-255. Please make sure that the IP addresses do not conflict.

6. Click "Subnet Mask" and the computer will automatically calculate the subnet mask of the address;

7. Click OK.

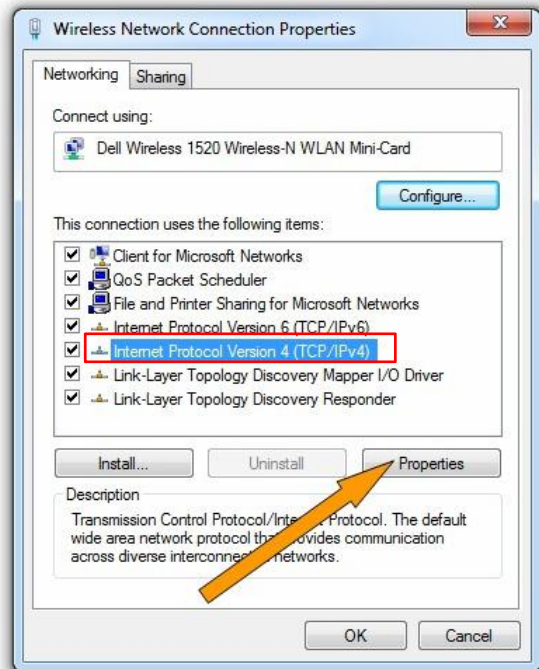
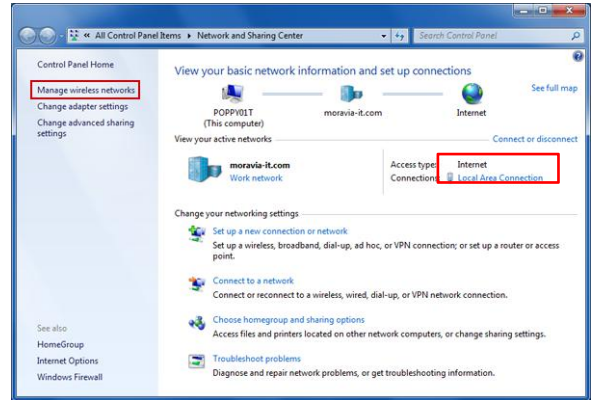

IP Address	192 . 168 . 0 . 101
Subnet Mask	255 . 255 . 255 . 0
Default Gateway	192 . 168 . 0 . 1

5.1.2 Static Direct Connection

To ensure that XPOSE mini can connect in different classes of subnet masks, if you find that you cannot connect to the mini+ series by searching, please try to use the direct connection method. The direct connection feature was added after XPOSE mini was updated to version V1.0.0.9.

1. Open XPOSE mini and click on the icon in the upper right corner



2. Enter the IP address of the currently connected mini+.



5.1.3 Connect Wirelessly with Your Router

The mini+ provides wireless control, so you can control it from a greater distance when the mini+ is not in your immediate vicinity. A wireless router is required to use this feature. The computer receives the wi-fi signal from the wireless router you connect the mini+ to.

Steps of wireless connection:

1. Connect the mini+ to the router's LAN port.
2. Press the "M" button

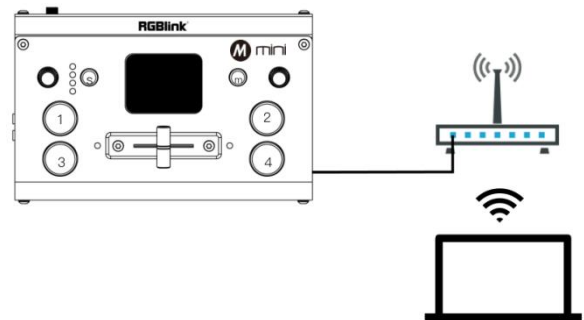

3. Enter the IP settings sub-menu
4. Turn on the DHCP switch.
5. Computer connects to Wi-Fi from the router.
6. Open XPOSE mini search

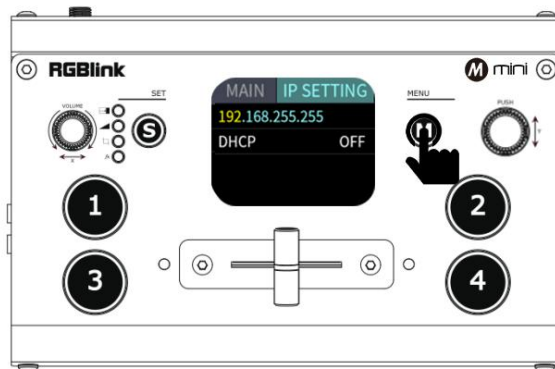

Note:The Android and IOS versions can only connect wirelessly. Regardless of whether you are using wireless or wired, you need to make sure that the IP addresses are on the same network segment and that they do not conflict.

5.2 Using XPOSE mini

XPOSE mini simulates the mini+'s real world appearance and the operations you can control with XPOSE mini are very similar to those you can do with the mini+'s hardware. XPOSE mini has put all the functions in the "M" button. You can use this button for functions that are not possible with the mini+ hardware.

Install dedicated software named XPOSE to control mini+.

Right click the setup exe file .

Choose *Run as administrator* to open the exe and install the software.

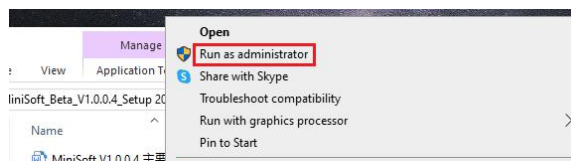

After software is installed, click the icon



XPOSE and login the software.



Click Search to search mini+ device.

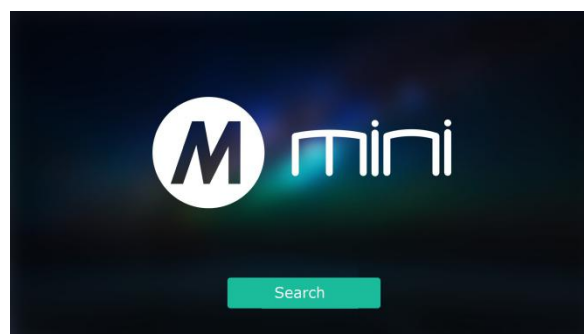

After searching, all available mini+ devices in the sub-net can be found, up to 128 devices can be found if there are.

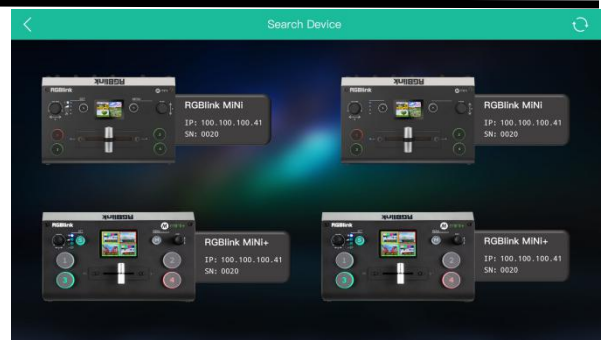

Select the desired device by SN and IP and enter the management interface. The software interface is a simulation of operation panel on real mini+ device.

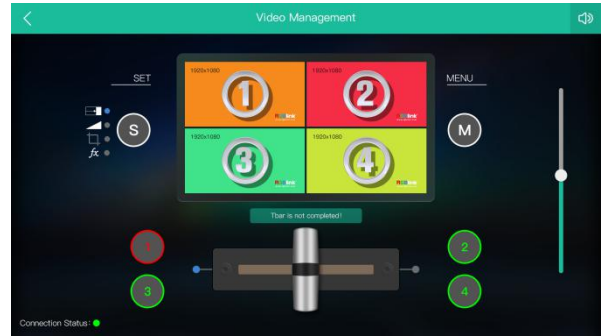

For example, clicking Button M  can open up menu as on the device. If it is the first time for you to use XPOSE mini, we suggest you watch our User Guide video.

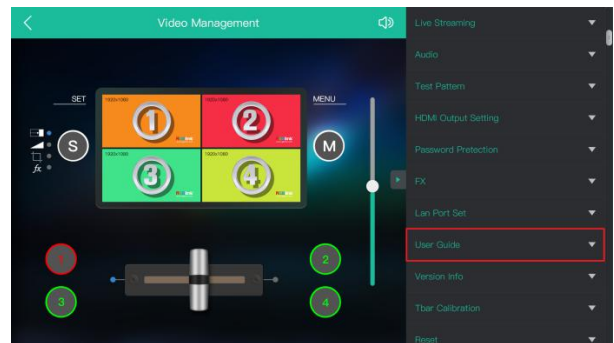

5.2.1 User Guide

Click the drop down arrow and click to play the User Guide video.

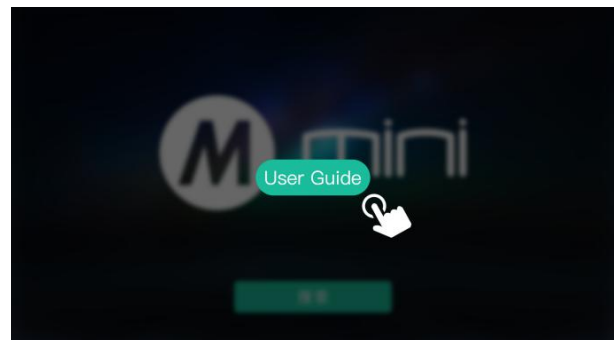
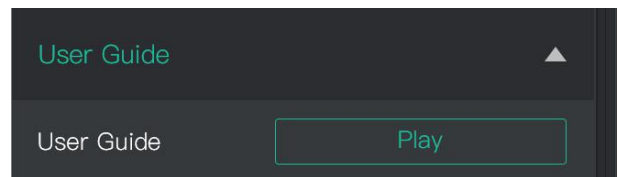

If you have used XPOSE mini before, you can directly click MENU to set as on mini+.

Following sections are dedicated to the additional features of XPOSE mini.

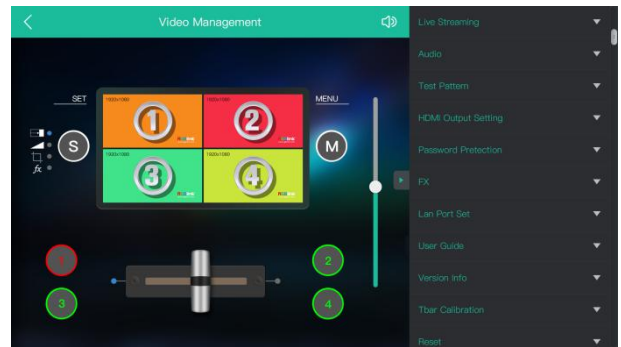

5.2.2 Live Streaming

Device Capture: choose RGBlink USB3.0 Capture

H.265: When it is ON, users can watch 4 inputs streaming back on XPOSE software.

Import the related OBS application if users need to do live streaming, click Relate to confirm.

OBS: slide ON to start streaming.

Note: H.265 and OBS cannot work at the same time. User choose either H.265 or OBS, not both.

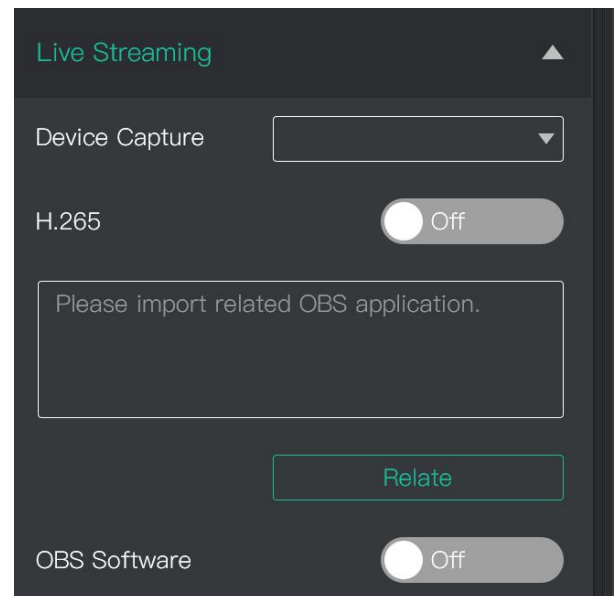

5.2.3 Test Pattern

To facilitate troubleshooting, XPOSE mini provides a test signal output, which can be used to troubleshoot the USB or HDMI output interface when there is no output signal from USB or HDMI.

1. Select the USB/HDMI interface to be tested.

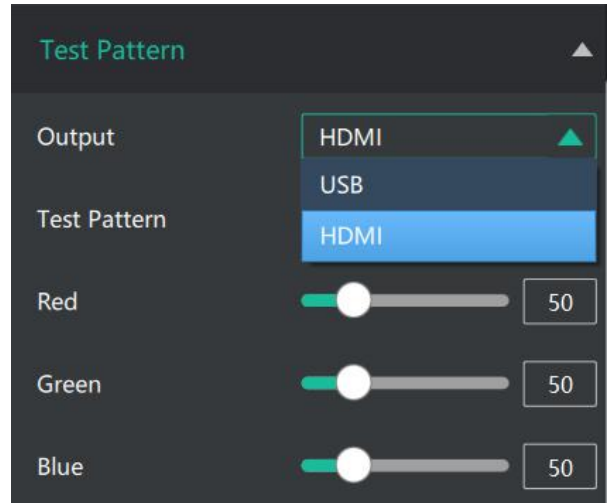

2. Select the mode of the test pattern.

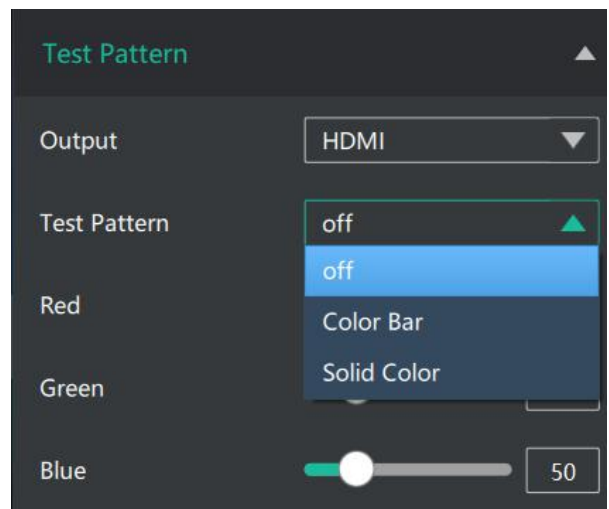

3. Adjust color.

5.2.4 Password Protection

In order to solve the problem of control conflicts caused by different devices controlling the same mini+ in the same LAN, XPOSE mini provides a password protection function, as an administrator, you can set a password for the device controlling XPOSE mini, and when you control the interface again, you need to enter the password to control it.

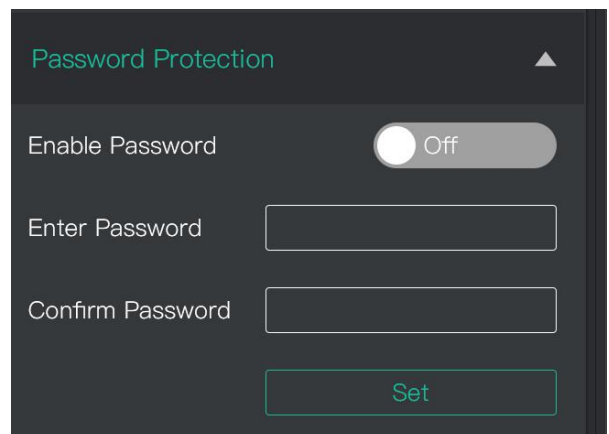

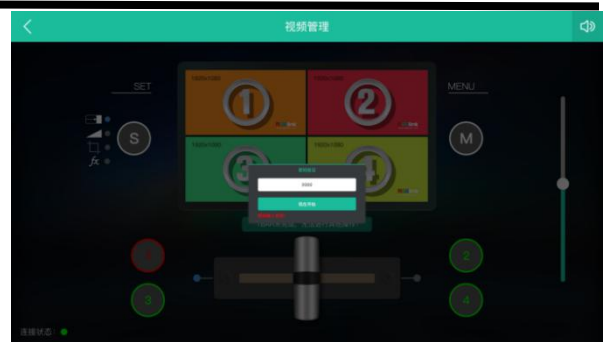

Note: If you have forgotten your password, please restore the factory settings on the mini+

5.2.5 T-Bar Calibration

If the T-Bar is not in the correct position, no other operation is possible. t-Bar correction is available in XPOSE mini.

The steps are as follow:

1. Turn on the T-Bar Calibration switch.
2. Push the T-Bar to the **far right** on the mini+.
3. Turn on the "On" switch
4. Push the T-Bar to the **far left** on the mini+.
5. Turn on the "On" switch

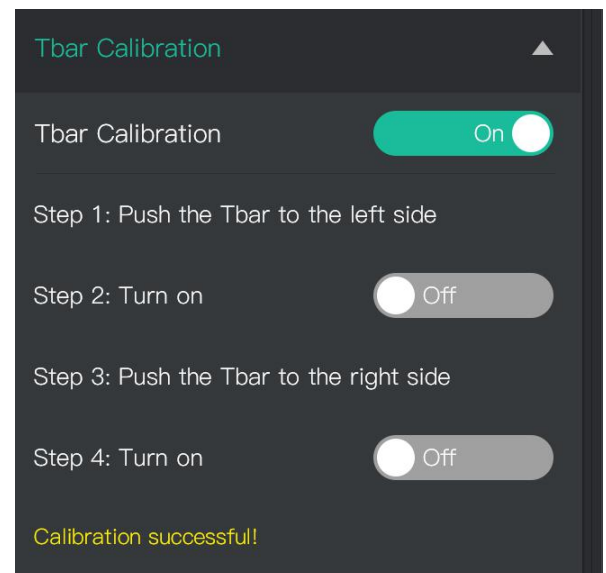

FX

More features on mini+ .

They are Chroma key, PTZ Camera Setting and Logo Overlay

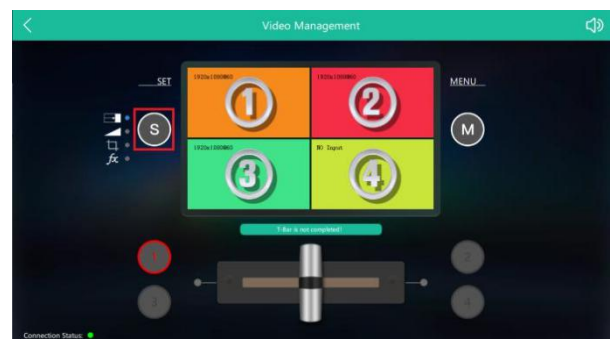

5.2.6 Chroma Key

mini+ also provides Chroma Key of sub-screens. Sub-screen key is possible with PIP turned on, which helps you to combine characters with the virtual background. Make sure to use XPOSE mini V1.0.0.9 or higher before using the latest program, and make sure to use mini+ V1.23 and higher.

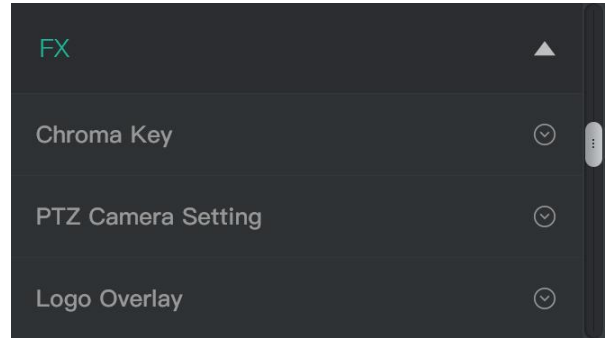

1. Select the base color you want to remove, there are 6 kinds of colors you can select: orange, yellow, green, cyan, blue and purple.

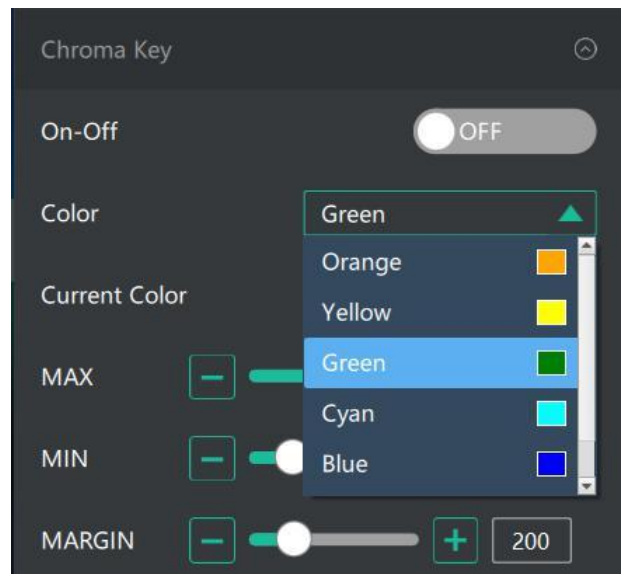

2. Adjust color in the range of MAX, MIN and MARGIN. You can click in the MAX MIN MARGIN data input box to achieve a more precise keying effect.

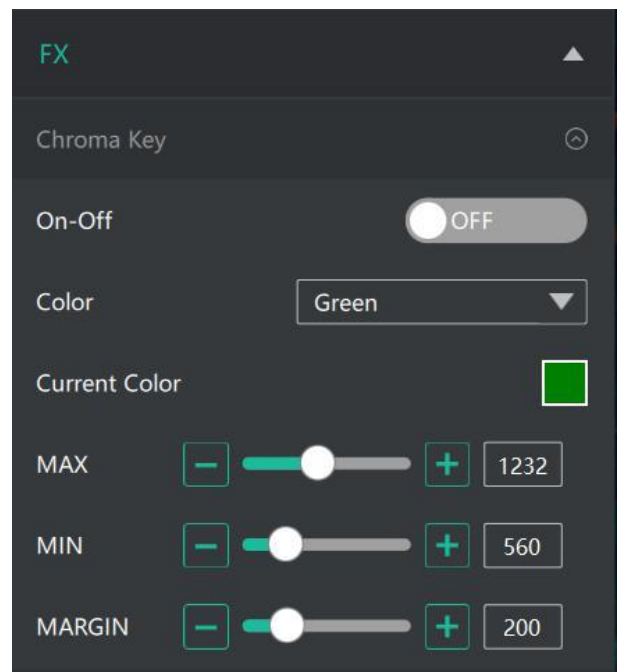

3. Chroma key effect on mini+ as shown in the figure.



Note: When using chroma key, make sure that the layer you want to edit is on the top layer, which is the B layer in the PIP setting, otherwise you may not see the chromakey effect.

5.2.7 PTZ Camera Setting

When controlling the PTZ camera, the computer, mini+ and PTZ camera should be in the same network segment.

1. Set the corresponding communication port on the PTZ camera, such as VISCA or UDP port 1259.

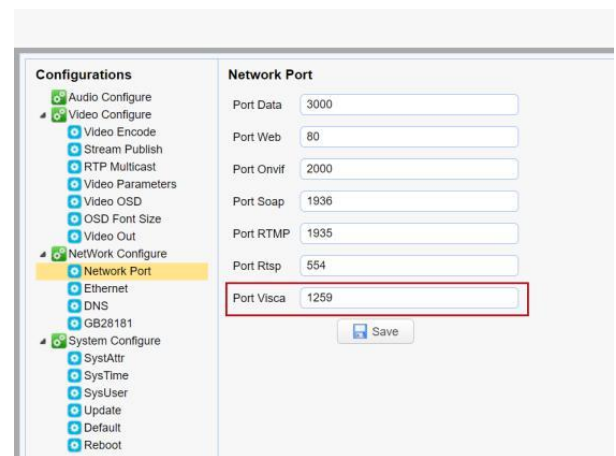

2. Set both old IP and new IP to the camera IP address you want to control, the corresponding communication port to 1259 on mini+, configuration path: M(Menu) → FX → PTZ Camera Setting Port on the control software of mini+.



3. After IP address setting,turn on “Enable” and you can control PTZ camera.

You can click and to set camera to zoom and focus.Turn on “Auto” ,the camera will zoom and focus automatically.

You can slide to set brightness.

You can also slide to set Pan/Tilt speed of camera.

Click to set camera’ s rotation position.

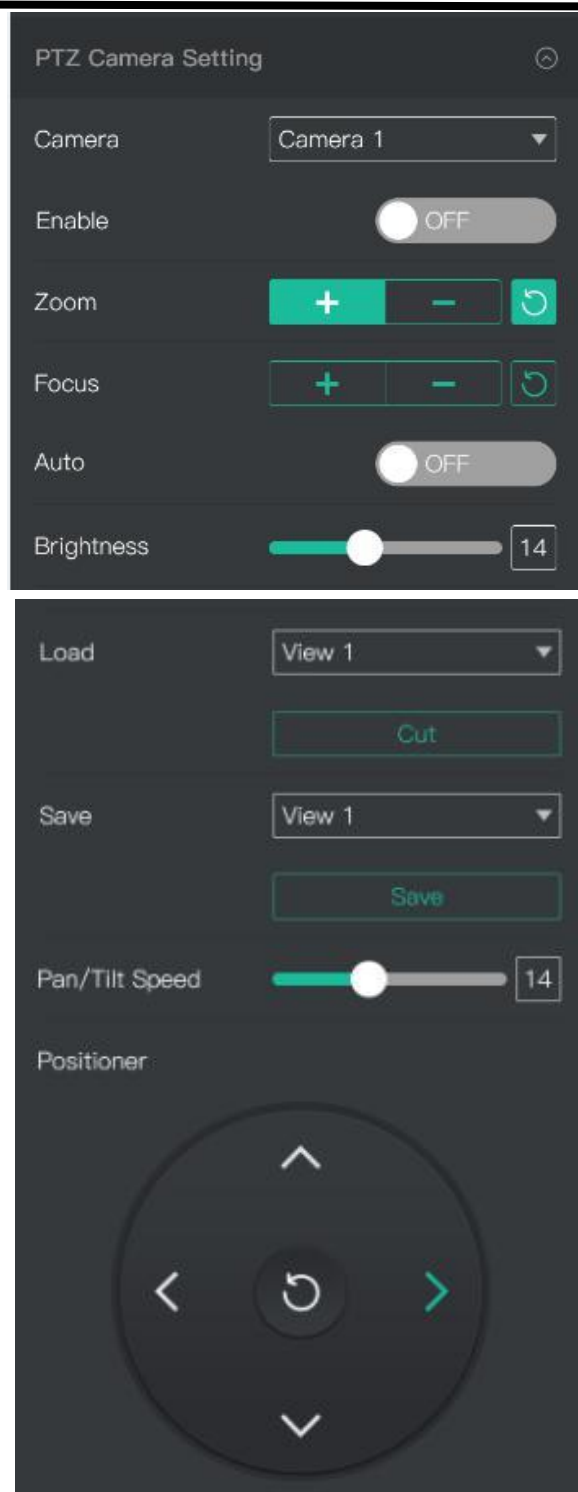

5.2.8 Logo Overlay

If it is your first time to use Logo Overlay, please connect mini+ to your computer, and make sure that IP address of both are in the same network segment.

1. Select a picture as the Logo.
2. Click “ColorPicker” and select color you want to filter in the LOGO picture, and current color can be seen below.
3. Turn on “Transparent Switch”, the filtered color will disappear in the LOGO picture.
4. Click “Logo Generated”, “upgrading” will be seen in the TFT screen of mini+, and the Logo picture will be imported in.
5. Turn on “On-Off”, and slide to set camera “X” and “Y” position. Click Set and confirm.

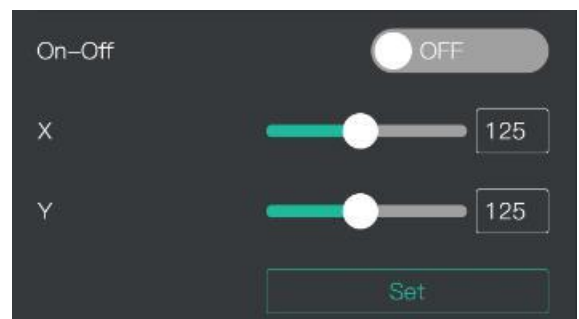
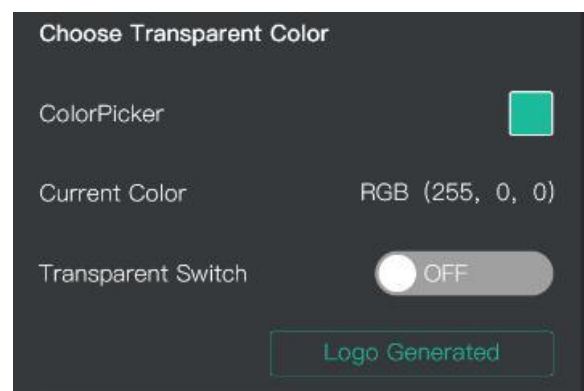
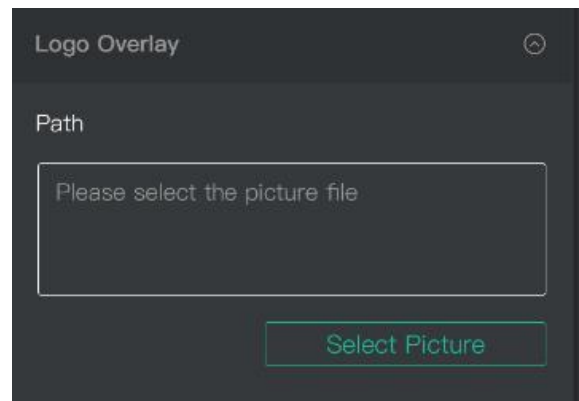

Note: The format of the LOGO image should be BMP 24 bits, and the image size should be within 256*128 pixels.

5.3 Upgrade

1.Tools:

- Firmware ZIP upgrade package
- XTOOL (V1.0.1.10 or higher) -packaged in the ZIP
- Computer with network connection
 - Windows (minimum Win 7, Win 10 recommended)
 - macOS (minimum 10.13 High Sierra)



2.Upgrade

2.1 Power on the device and connect LAN ports between PC and device by Cat6 cable;

2.2 Ensure that your computer is on the same network as the mini-pro. The default IP address of mini-pro is 192.168.0.99, in which case your computers IP address should be in the range 192.168.0.xxx (xxx cannot be the same as mini-pro or other device on the network) to enable connection between the mini-pro and your computer.

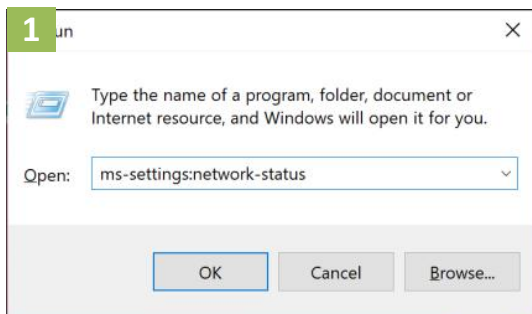
Check IP of PC:



1. Press  +  keys together to open the Command Prompt; In the dialog type: ms-settings:network-status

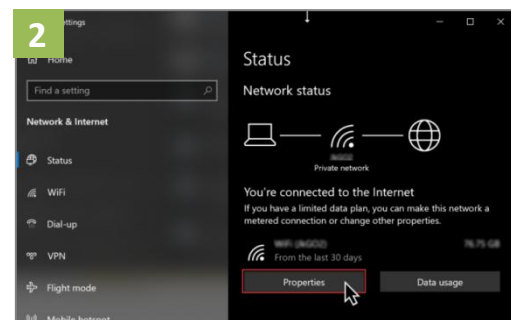

1. Click on the “Properties” button

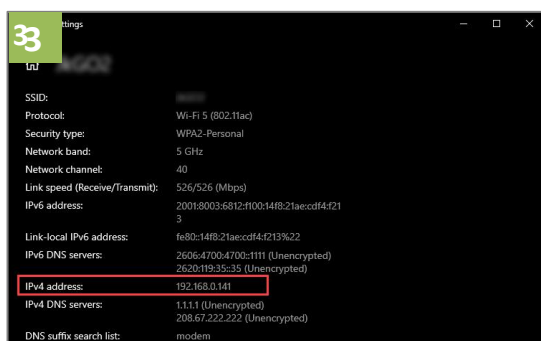

3. Scroll down to find your IP address

If the IP address is not in the same section, manual change of IP address is required. Here are the steps:

- Step 1. Click Start menu, click “Setting”
- Step 2. Open **Network and Internet > Network and Sharing Center**.
- Step 3. On the left pane of the new window, click **Change adapter settings**.
- Step 4. You will be displayed with **Network Connections** of the PC.
Important note: Right click on “Ethernet” or “Local Area Connection” if you want to change IP of any physical connection. And right click on “WLAN” in case you wish to change IP of any wireless connections.
- Step 5. Choose **Properties** after right clicking on the network name.
- Step 6. Select the **Internet Protocol Version 4 (TCP/IPv4)**, then click **Properties**.
- Step 7. **Obtain an IP Address automatically** should be selected by default, but please choose the **Use the Following IP Address**.
- Step 8. Now put your desired IP Address according to your wish its correct format. Change **Subnet mask and default gateway** if you want to.

Install XTOOL App

- Step 1. Extract the Firmware ZIP package into a folder
 - Step 2. Navigate to the **/Upgrade Tool/XTOOL** folder
 - Step 3. Right mouse-click the XTOOL Soft Setup and **Run as Administrator** [Windows]
 - Step 3. Follow the Setup Wizard to install all the components. There will be multiple Dialog windows pop-up for installing the necessary components (*refer XTOOL Installation Guide*)
- If the XTOOL app has been installed previously, use the **Modify** option to complete the setup.

XTOOL is a universal updater application for RGBlink products, as such has a number of features in support of the full range of RGBlink devices that are not utilized for mini-pro updates in this guide.

1. Upgrade

Open the XTOOL app with **Run as Administrator** [Windows]

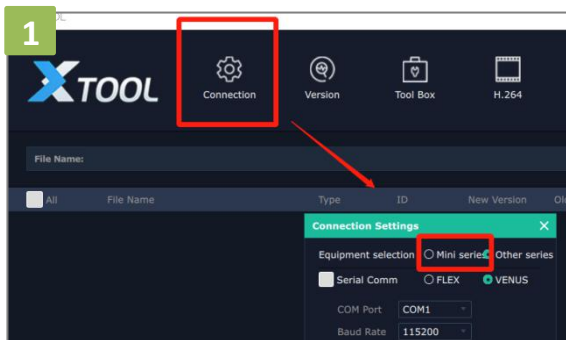

1. Click “**Connection**” and select “**mini series**”

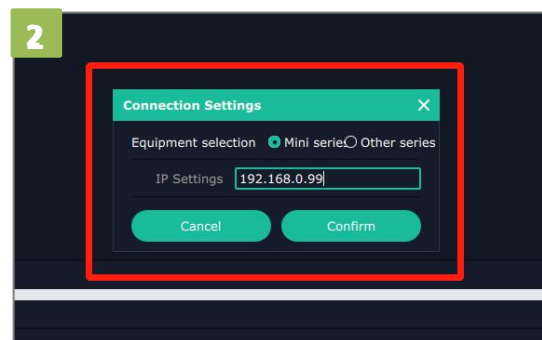

2. Fill in the IP Address of the mini-pro (as example above, default mini+ IP is 192.168.0.99), and click “**Confirm**”.

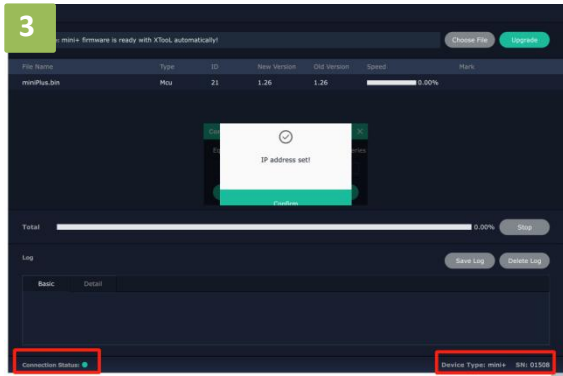

3. Review Connection Status at bottom left, to confirm indicator light is green and there is device information showing at bottom right.

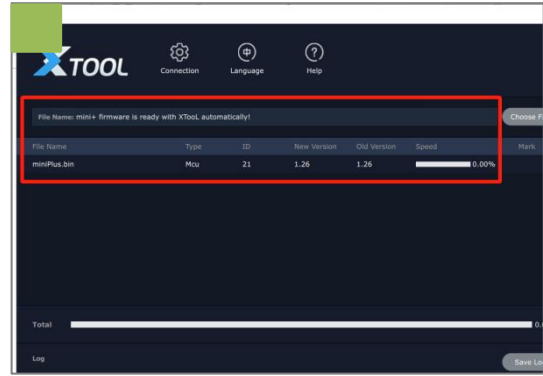

4. The firmware package will be ready with XTOOL automatically.

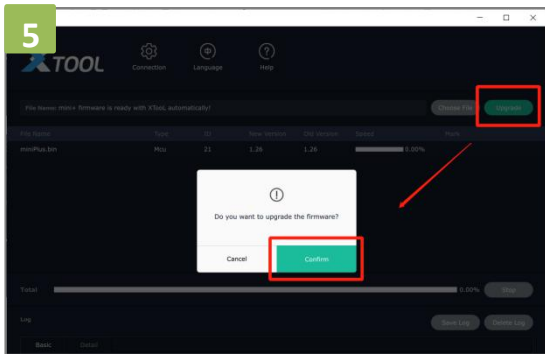

5. Click "Upgrade" and click "Confirm" in the pop-up windows.

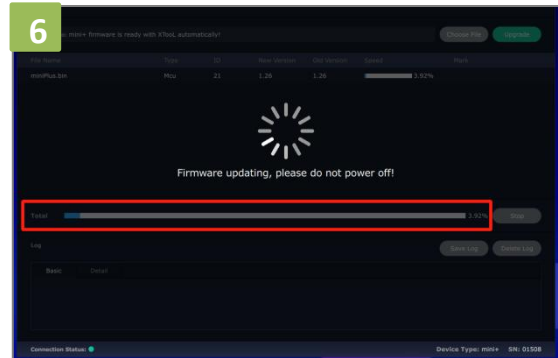

6. Firmware is upgrading and you can monitor the progress. Please do not power off while upgrading.

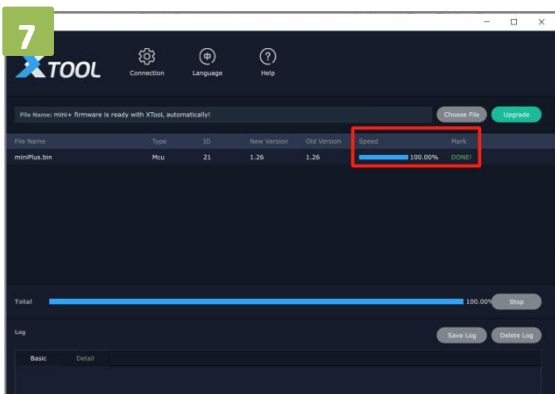

7. mini+ is now upgraded and ready to use.

Chapter 6 Ordering Codes

6.1 Product Code

230-0001-02-0

mini+

Chapter 7 Support

7.1 Contact US

www.rgblink.com



Inquiries

☎ +86-592-577-1197
✉ info@rgblink.com
🌐 rgblink.com/contact-us

Global Support

✉ support@rgblink.com
🌐 rgblink.com/support-me



@RGLINK



/rgblink



+rgblink



/rgblink



rgblink



rgblink

RGBlink Headquarters Xiamen, China 6 th Floor Weiye Building Torch Park Hi Tech Zone Huli ✉ sales@rgblink.com ☎ +86-592-577-1197	China Regional Sales & Support Shenzhen, China 11 th Floor Baiwang Building 5318 Shahe West Road Baimang, Nanshan ☎ +86-755-2153-5149	Beijing Region Office Beijing, China Building 8, 25 Qixiao Road Shahe Town Changping ☎ +86- 4008-592-114	Europe Regional Sales & Support Eindhoven, Holland Flight Forum Eindhoven 5657 DW ✉ eu@rgblink.com ☎ +31(040)-202-71-83	India Regional Sales & Support Mumbai, India 78/626, Motilal Nagar, No1, Rd No1, Goregaon West, Mumbai ✉ support@rgblink.com ☎ +91-98200-86718
---	--	---	---	--

Chapter 8 Appendix

8.1 Specification

Connectors	Input	HDMI In	4×HDMI-A	
	Output	HDMI Out	1×HDMI-A	
		USB 3.0	1×USB TypeA	
	Audio	In	1×3.5mm Stereo Jack	
		Out	1×3.5mm Stereo Jack	
	Communication	LAN	1×RJ45	
	Power		1×DC Power Jack	
Performance	Input Resolutions	HDMI		
		SMPTE	720p@50/60 1080i@50 1080p@23/24/30/50/60	
	Output Resolutions	VESA	1024×768@60 1280×720@60 1280×768@60 1280×800@60 1280×1024@60 1360×768@60 1366×768@60 1440×900@60 1600×1200@60 1680×1050@60 1920×1080@60 1920×1200@60	
		HDMI		
		SMPTE	720p@60 1080p@60	
Supported Standards	VESA	1024×768@60 1280×720@60 1280×768@60 1280×1024@60 1360×768@60 1920×1080@60		
	USB H.265	1024×768@60 1280×720@60 1280×1024@60 1360×768@60 1920×1080@60		
	H.265	ITU-T H.265/ ISO/IEC 23008-2		
Power	Input Voltage	DC 12V/1.5A		
	Contact Power	13.2W		
	Max Power	18W		
Environment	Temperature	0°C~70°C		
	Humidity	10%~85%		
Physical	Weight	Net	0.5kg	
		Package	1.25kg	
	Dimension	Net	180mm×112.5mm×48.7mm	
		Package	255mm×145mm×85mm	

8.2 Terms & Definitions

- **RCA:** Connector used primarily in consumer AV equipment for both audio and video. The RCA connector was developed by the Radio Corporation of America.
- **BNC:** Stands for Bayonet Neill-Concelman. A cable connector used extensively in television (named for its inventors). A cylindrical bayonet connector that operates with a twist-locking motion .
- **CVBS:** CVBS or Composite video, is an analog video signal without audio. Most commonly CVBS is used for transmission of standard definition signals. In consumer applications the connector is typically RCA type, while in professional applications the connector is BNC type.
- **YPbPr:** Used to describe the colour space for progressive-scan. Otherwise known as component video.
- **VGA:** Video Graphics Array. VGA is an analog signal typically used on earlier computers. The signal is non-interlaced in modes 1, 2, and 3 and interlaced when using in mode.
- **DVI:** Digital Visual Interface. The digital video connectivity standard that was developed by DDWG (Digital Display Work Group). This connection standard offers two different connectors: one with 24 pins that handles digital video signals only, and one with 29 pins that handles both digital and analog video.
- **SDI:** Serial Digital Interface. Standard definition video is carried on this 270 Mbps data transfer rate. Video pixels are characterized with a 10-bit depth and 4:2:2 color quantization. Ancillary data is included on this interface and typically includes audio or other metadata. Up to sixteen audio channels can be transmitted. Audio is organised into blocks of 4 stereo pairs. Connector is BNC.
- **HD-SDI:** High-definition serial digital interface (HD-SDI), is standardized in SMPTE 292M this provides a nominal data rate of 1.485 Gbit/s.
- **3G-SDI:** Standardized in SMPTE 424M, consists of a single 2.970 Gbit/s serial link that allows replacing dual link HD-SDI.
- **6G-SDI:** Standardized in SMPTE ST-2081 released in 2015, 6Gbit/s bitrate and able to support 2160p@30.
- **12G-SDI:** Standardized in SMPTE ST-2082 released in 2015, 12Gbit/s bitrate and able to support 2160p@60.
- **U-SDI:** Technology for transmitting large-volume 8K signals over a single cable. a signal interface called the ultra high definition signal/data interface (U-SDI) for transmitting 4K and 8K signals using a single optical cable. The interface was standardized as the SMPTE ST 2036-4.
- **HDMI:** High Definition Multimedia Interface: An interface used for the transmission of uncompressed high definition video, up to 8 channels of audio, and control signals, over a single cable.
- **HDMI 1.3:** Released on June 22 2006, and increased the maximum TMDS clock to 340 MHz (10.2 Gbit/s). Support

resolution 1920 × 1080 at 120 Hz or 2560 × 1440 at 60 Hz). It added support for 10 bpc, 12 bpc, and 16 bpc color depth (30, 36, and 48 bit/px), called deep color.

●**HDMI 1.4:** Released on June 5, 2009, added support for 4096 × 2160 at 24 Hz, 3840 × 2160 at 24, 25, and 30 Hz, and 1920 × 1080 at 120 Hz. Compared to HDMI 1.3, 3 more features added which are HDMI Ethernet Channel (HEC), audio return channel (ARC), 3D Over HDMI, a new Micro HDMI Connector, an expanded set of color spaces.

●**HDMI 2.0:** Released on September 4, 2013 increases the maximum bandwidth to 18.0 Gbit/s. Other features of HDMI 2.0 include up to 32 audio channels, up to 1536 kHz audio sample frequency, the HE-AAC and DRA audio standards, improved 3D capability, and additional CEC functions.

●**HDMI 2.0a:** Was released on April 8, 2015, and added support for High Dynamic Range (HDR) video with static metadata.

●**HDMI 2.0b:** Was released March, 2016, support for HDR Video transport and extends the static metadata signaling to include Hybrid Log-Gamma (HLG).

●**HDMI 2.1:** Released on November 28, 2017. It adds support for higher resolutions and higher refresh rates, Dynamic HDR including 4K 120 Hz and 8K 120 Hz.

●**DisplayPort:** A VESA standard interface primarily for video, but also for audio, USB and other data. DisplayPort (or DP) is backwards compatible with HDMI, DVI and VGA.

●**DP 1.1:** Was ratified on 2 April 2007, and version 1.1a was ratified on 11 January 2008. DisplayPort 1.1 allow a maximum bandwidth of 10.8 Gbit/s (8.64 Gbit/s data rate) over a standard 4-lane main link, enough to support 1920x1080@60Hz

●**DP 1.2:** Introduced on 7 January 2010, effective bandwidth to 17.28 Gbit/s support increased resolutions, higher refresh rates, and greater color depth, maximum resolution 3840 × 2160@60Hz

●**DP 1.4:** Publish on 1 Mar, 2016. overall transmission bandwidth 32.4 Gbit/s, DisplayPort 1.4 adds support for Display Stream Compression 1.2 (DSC), DSC is a "visually lossless" encoding technique with up to a 3:1 compression ratio. Using DSC with HBR3 transmission rates, DisplayPort 1.4 can support 8K UHD (7680 × 4320) at 60 Hz or 4K UHD (3840 × 2160) at 120 Hz with 30 bit/px RGB color and HDR. 4K at 60 Hz 30 bit/px RGB/HDR can be achieved without the need for DSC.

●**Multi-mode Fiber:** Fibers that support many propagation paths or transverse modes are called multi-mode fibers, generally have a wider core diameter and are used for short-distance communication links and for applications where high power must be transmitted.

●**Single-mode Fiber:** Fiber that support a single mode are called single-mode fibers. Single-mode fibers are used for most communication links longer than 1,000 meters (3,300 ft).

●**SFP:** Small form-factor pluggable, is a compact, hot-pluggable network interface module used for both telecommunication and data communications applications.

●**Optical Fiber Connector:** Terminates the end of an optical fiber, and enables quicker connection and disconnection than splicing. The connectors mechanically couple and align the cores of fibers so light can pass. 4 most common types

of optical fiber connectors are SC, FC, LC,ST.

●**SC:** (Subscriber Connector), also known as the square connector was also created by the Japanese company – Nippon Telegraph and Telephone. SC is a push-pull coupling type of connector and has a 2.5mm diameter. Nowadays, it is used mostly in single mode fiber optic patch cords, analog, GBIC, and CATV. SC is one of the most popular options, as its simplicity in design comes along with great durability and affordable prices.

●**LC:** (Lucent Connector) is a small factor connector (uses only a 1.25mm ferrule diameter) that has a snap coupling mechanism. Because of its small dimensions, it is the perfect fit for high-density connections, XFP, SFP, and SFP+ transceivers.

●**FC:** (Ferrule Connector) is a screw type connector with a 2.5mm ferrule. FC is a round shaped threaded fiber optic connector,mostly used on Datacom, telecom, measurement equipment, single-mode laser.

●**ST:** (Straight Tip) was invented by AT&T and uses a bayonet mount along with a long spring-loaded ferrule to support the fiber.









●**USB:** Universal Serial Bus is a standard that was developed in the mid-1990s that defines cables, connectors and communication protocols. This technology is designed to allow a connection, communication and power supply for peripheral devices and computers.

●**USB 1.1:** Full-Bandwidth USB, specification was the first release to be widely adopted by the consumer market. This specification allowed for a maximum bandwidth of 12Mbps.

●**USB 2.0:** or Hi-Speed USB, specification made many improvements over USB 1.1. The main improvement was an increase in bandwidth to a maximum of 480Mbps.

● **USB 3.2:** Super Speed USB with 3 varieties of 3.2 Gen 1(original name USB 3.0), 3.2Gen 2(original name USB 3.1), 3.2 Gen 2x2 (original name USB 3.2) with speed up to 5Gbps,10Gbps,20Gbps respectively.

USB version and connectors figure:

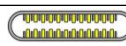
	Type A	Type B	Mini A	Mini B	Micro-A	Micro-B	Type C
USB 2.0							
USB 3.0							
USB 3.1&3.2							

●**NTSC:** The colour video standard used in North America and some other parts of the world created by the National Television Standards Committee in the 1950s. NTSC utilizes an interlaced video signals.

●**PAL:** Phase Alternate Line. A television standard in which the phase of the colour carrier is alternated from line to line. It takes four full images (8 fields) for the colour-to-horizontal images (8 fields) for the colour-to-horizontal phase relationship to return to the reference point. This alternation helps cancel out phase errors. For this reason, the hue control is not needed on a PAL TV set. PAL, is widely used in Western Europe, Australia, Africa, the Middle East, and Micronesia. PAL uses 625-line, 50-field (25 fps) composite colour transmission system.

●**SMPTE:** Society of Motion image and Television Engineers. A global organization, based in the United States, that sets standards for baseband visual communications. This includes film as well as video and television standards.

●**VESA:** Video Electronics Standards Association. An organization facilitating computer graphics through standards.

●**HDCP:** High-bandwidth Digital Content Protection (HDCP) was developed by Intel Corporation and is in wide use for protection of video during transmission between devices.

●**HDBaseT:** A video standard for the transmission of uncompressed video (HDMI signals) and related features using Cat 5e/Cat6 cabling infrastructure.

●**ST2110:** A SMPTE developed standard, ST2110 describes how to send digital video over and IP networks. Video is transmitted uncompressed with audio and other data in a separate streams. SMPTE2110 is intended principally for broadcast production and distribution facilities where quality and flexibility are more important.

●**SDVoE:** Software Defined Video over Ethernet (SDVoE) is a method for transmission, distribution and management AV signals using a TCP/IP Ethernet infrastructure for transport with low latency. SDVoE is commonly used in integration applications.

●**Dante AV:** The Dante protocol was developed for and widely adopted in audio systems for the transmission of uncompressed digital audio on IP based networks. The more recent Dante AV specification includes support for digital video.

●**NDI:** Network Device interface (NDI) is a software standard developed by NewTek to enable video-compatible products to communicate, deliver, and receive broadcast quality video in a high quality, low latency manner that is frame-accurate and suitable for switching in a live production environment over TCP (UDP) Ethernet based networks. NDI is commonly found in broadcast applications.

●**RTMP:** Real-Time Messaging Protocol (RTMP) was initially a proprietary protocol developed by Macromedia (now Adobe) for streaming audio, video and data over the Internet, between a Flash player and a server.

●**RTSP:** The Real Time Streaming Protocol (RTSP) is a network control protocol designed for use in entertainment and communications systems to control streaming media servers. The protocol is used for establishing and controlling media sessions between end points.

●**MPEG:** Moving Picture Experts Group is a working group formed from ISO and IEC developing standards that allow audio/video digital compression and Transmission.

●**H.264:** Also known as AVC (Advanced Video Coding) or MPEG-4i is a common video compression standard. H.264 was standardized by the ITU-T Video Coding Experts Group (VCEG) together with the ISO/IEC JTC1 Moving Picture Experts Group (MPEG).

●**H.265:** Also known as **HEVC** (High Efficiency Video Coding) H.265 is the successor to the widely used H.264/AVC digital video coding standard. Developed under the auspices of ITU, resolutions up to 8192x4320 may be compressed.

●**API:** An Application Programming Interface (API) provides a predefined function which allows access capabilities and features or routines via a software or hardware, without accessing source code or understanding the details of inner working mechanism. An API call may execute a function and/or provide data feedback/report.

●**DMX512:** The communication standard developed by USITT for entertainment and digital lighting systems. The wide adoption of the Digital Multiplex (DMX) protocol has seen the protocol used for a wide range of other devices including video controllers. DMX512 is delivered over cable of 2 twisted pairs with 5pin XLR cables for connection.

●**ArtNet:** An ethernet protocol based on TCP/IP protocol stack, mainly used in entertainment/events applications. Built on the DMX512 data format, ArtNet enables multiple “universes” of DMX512 to be transmitted using ethernet networks for transport.

●**MIDI:** MIDI is the abbreviation of Musical Instrument Digital Interface. As the name indicates the protocol was developed for communication between electronic musical instruments and latterly computers. MIDI instructions are triggers or commands sent over twisted pair cables, typically using 5pin DIN connectors.

●**OSC:** The principle of Open Sound Control (OSC) protocol is for networking sound synthesizers, computers, and multimedia devices for musical performance or show control. As with XML and JSON, the OSC protocol allows sharing data. OSC is transported via UDP packets between devices connected on an Ethernet.

●**Brightness:** Usually refers to the amount or intensity of video light produced on a screen without regard to colour. Sometimes called black level.

●**Contrast Ratio:** The ratio of the high light output level divided by the low light output level. In theory, the contrast ratio of the television system should be at least 100:1, if not 300:1. In reality, there are several limitations. Well-controlled viewing conditions should yield a practical contrast ratio of 30:1 to 50:1.

●**Colour Temperature:** The colour quality, expressed in degrees Kelvin (K), of a light source. The higher the colour temperature, the bluer the light. The lower the temperature, the redder the light. Benchmark colour temperature for the A/V industry include 5000°K, 6500°K, and 9000°K.

●**Saturation:** Chroma, Chroma gain. The intensity of the colour, or the extent to which a given colour in any image is free from white. The less white in a colour, the truer the colour or the greater its saturation. Saturation is the amount of pigment in a colour, and not the intensity.

●**Gamma:** The light output of a CRT is not linear with respect to the voltage input. The difference between what

you should have and what is actually output is known as gamma.

- **Frame:** In interlaced video, a frame is one complete image. A video frame is made up of two fields, or two sets of interlaced lines. In a film, a frame is one still image of a series that makes up a motion image.
- **Genlock:** Allows synchronisation of otherwise video devices. A signal generator provides a signal pulses which connected devices can reference. Also see Black Burst and Color Burst.
- **Blackburst:** The video waveform without the video elements. It includes the vertical sync, horizontal sync, and the Chroma burst information. Blackburst is used to synchronize video equipment to align the video output.
- **Colour Burst:** In colour TV systems, a burst of subcarrier frequency located on the back part of the composite video signal. This serves as a colour synchronizing signal to establish a frequency and phase reference for the Chroma signal. Colour burst is 3.58 MHz for NTSC and 4.43 MHz for PAL.
- **Colour Bars:** A standard test pattern of several basic colours (white, yellow, cyan, green, magenta, red, blue, and black) as a reference for system alignment and testing. In NTSC video, the most commonly used colour bars are the SMPTE standard colour bars. In PAL video, the most commonly used colour bars are eight full field bars. On computer monitors the most commonly used colour bars are two rows of reversed colour bars
- **Seamless Switching:** A feature found on many video switchers. This feature causes the switcher to wait until the vertical interval to switch. This avoids a glitch (temporary scrambling) which often is seen when switching between sources.
- **Scaling:** A conversion of a video or computer graphic signal from a starting resolution to a new resolution. Scaling from one resolution to another is typically done to optimize the signal for input to an image processor, transmission path or to improve its quality when presented on a particular display.
- **PIP:** Picture-In-Picture. A small image within a larger image created by scaling down one of image to make it smaller. Other forms of PIP displays include Picture-By-Picture (PBP) and Picture- With-Picture (PWP), which are commonly used with 16:9 aspect display devices. PBP and PWP image formats require a separate scaler for each video window .
- **HDR:** is a high dynamic range (HDR) technique used in imaging and photography to reproduce a greater dynamic range of luminosity than what is possible with standard digital imaging or photographic techniques. The aim is to present a similar range of luminance to that experienced through the human visual system.
- **UHD:** Standing for Ultra High Definition and comprising 4K and 8K television standards with a 16:9 ratio, UHD follows the 2K HDTV standard. A UHD 4K display has a physical resolution of 3840x2160 which is four times the area and twice both the width and height of a HDTV/FullHD (1920x1080) video signal.
- **EDID:** Extended Display Identification Data. EDID is a data structure used to communicate video display information, including native resolution and vertical interval refresh rate requirements, to a source device. The source device will then output the provided EDID data, ensuring proper video image quality.

8.3 Revision History

The table below lists the changes to the User Manual.

Format	Time	ECO#	Description	Principal
V1.0	2021-05-06	0000#	Release	Sylvia

All information herein is Xiamen RGBlink Science & Technology Co Ltd. excepting noted.

视诚 RGBlink® RGBlink® is a registered trademark of Xiamen RGBlink Science & Technology Co Ltd.

While all efforts are made for accuracy at time of printing, we reserve the right to alter otherwise make change without notice.