

ASK pro

Wireless Presentation and Collaboration System



User Manual

RGBlink[®]

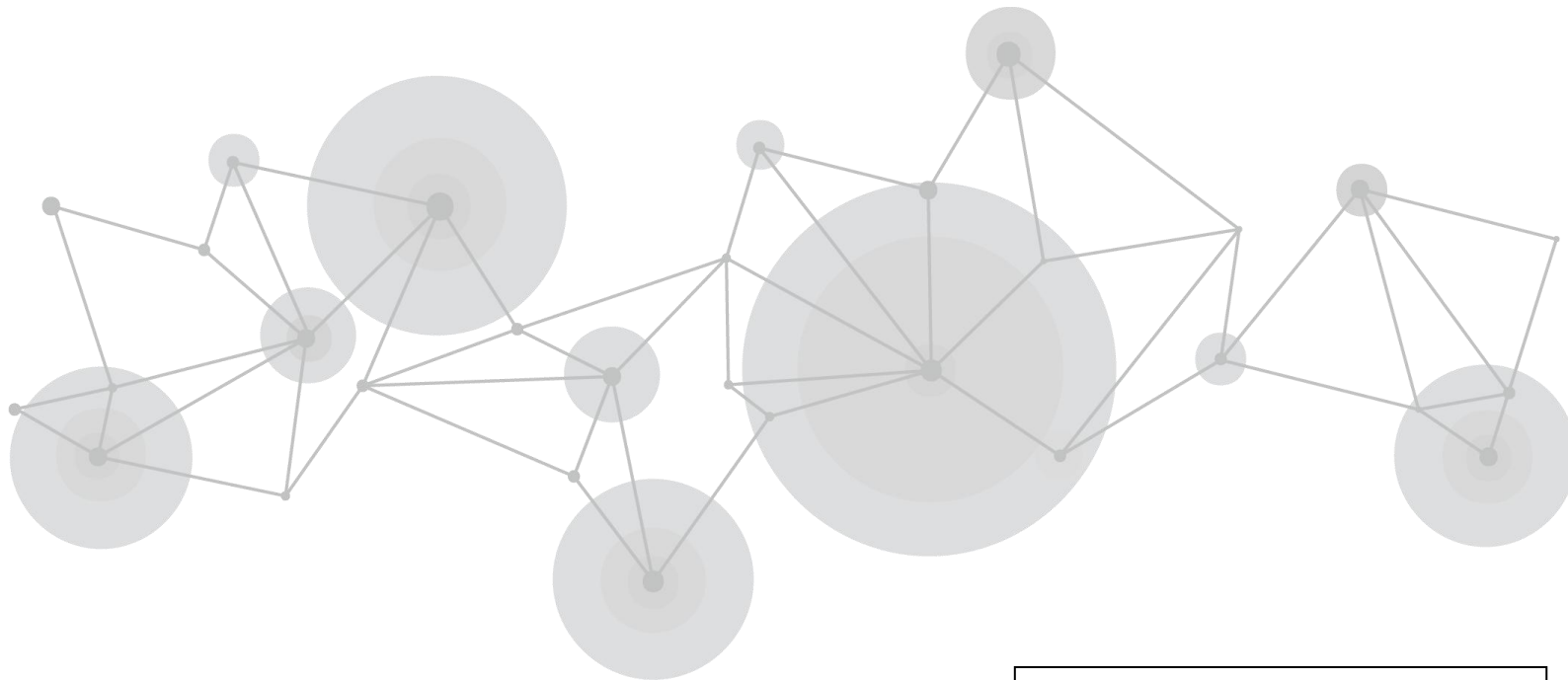

Article No: RGB-RD-UM- ASK pro E003
Revision No: V1.3

CONTENTS

CONTENTS	2
Declarations	3
FCC/Warranty	3
Operators Safety Summary	4
Installation Safety Summary	4
Chapter 1 Your Product	6
1.1 In the Box	6
1.2 Product Overview	6
1.2.1 Interface	8
Chapter 2 Install Your Product	10
Chapter 3 Use Your Product	12
3.1 MENU	12
3.3 Screen Mode	16
3.4 Multicast or Display Group Setup	17
Chapter 4 Order Codes	19
Chapter 5 Support	20
5.1 Contact Us	20
Chapter 6 Appendix	21
6.1 FAQ	21
6.2 Connection Supplement	22
6.3 Accessory Supplement	23
6.4 Specification	24
6.5 OpenAPI	25
6.6 Terms & Definitions	25
6.7 Revision History	32

Thank you for choosing our product!

This User Manual is designed to show you how to use this video processor quickly and make use of all the features. Please read all directions and instructions carefully before using this product.

Declarations

FCC/Warranty

Federal Communications Commission (FCC)

Statement

This equipment has been tested and found to comply with the limits for a class A digital device, pursuant to Part 15 of the FCC rules. These limits are designed to provide reasonable protection against harmful interference when the equipment is operated in a commercial environment. This equipment generates, uses, and can radiate radio frequency energy and, if not installed and used in accordance with the instruction manual, may cause harmful interference to radio communications. Operation of this equipment in a residential area may cause harmful interference, in which case the user will be responsible for correcting any interference.

Guarantee and Compensation

RGBlink provides a guarantee relating to perfect manufacturing as part of the legally stipulated terms of guarantee. On receipt, the purchaser must immediately inspect all delivered goods for damage incurred during transport, as well as for material and manufacturing faults. RGBlink must be informed immediately in writing of any complains.

The period of guarantee begins on the date of transfer of risks, in the case of special systems and software on the date of commissioning, at latest 30 days after the transfer of risks. In the event of justified notice of compliant, RGBlink can repair the fault or provide a replacement at its own discretion within an appropriate period. If this measure proves to be impossible or unsuccessful, the purchaser can demand a reduction in the purchase price or cancellation of the contract. All other claims, in particular those relating to compensation for direct or indirect damage, and also damage attributed to the operation of software as well as to other service provided by RGBlink, being a component of the system or independent service, will be deemed invalid provided the damage is not proven to be attributed to the absence of properties guaranteed in writing or due to the intent or gross negligence or part of RGBlink.

If the purchaser or a third party carries out modifications or repairs on goods delivered by RGBlink, or if the goods are handled incorrectly, in particular if the systems are

commissioned operated incorrectly or if, after the transfer of risks, the goods are subject to influences not agreed upon in the contract, all guarantee claims of the purchaser will be rendered invalid. Not included in the guarantee coverage are system failures which are attributed to programs or special electronic circuitry provided by the purchaser, e.g. interfaces. Normal wear as well as normal maintenance are not subject to the guarantee provided by RGBlink either.

The environmental conditions as well as the servicing and maintenance regulations specified in this manual must be complied with by the customer.

Operators Safety Summary

The general safety information in this summary is for operating personnel.

Do Not Remove Covers or Panels

There are no user-serviceable parts within the unit. Removal of the top cover will expose dangerous voltages. To avoid personal injury, do not remove the top cover. Do not operate the unit without the cover installed.

Power Source

This product is powered by USB on TX end and DC 5V at RX end.

Do Not Operate in Explosive Atmospheres

To avoid explosion, do not operate this product in an explosive atmosphere.

Installation Safety Summary

Safety Precautions

For all ASK pro installation procedures, please observe the following important safety and handling rules to avoid damage to yourself and the equipment.

To protect users from electric shock, ensure that the chassis connects to earth via the ground wire provided in the AC power Cord.

The AC Socket-outlet should be installed near the equipment and be easily accessible.

Unpacking and Inspection

Before opening ASK pro processor shipping box, inspect it for damage. If you find any damage, notify the shipping carrier immediately for all claims adjustments. As you open the box, compare its contents against the packing slip. If you find any shortages, contact your sales representative.

Once you have removed all the components from their packaging and checked that all the listed components are present, visually inspect the system to ensure there was no

damage during shipping. If there is damage, notify the shipping carrier immediately for all claims adjustments.

Site Preparation

The environment in which you install your ASK pro should be clean, properly lit, free from static, and have adequate power, ventilation, and space for all components.

Chapter 1 Your Product

1.1 In the Box

1*USB Cable

1*DC 5V 2A Power Adapter

1*USB Cable(male to female)

1*Type C to HDMI+USB3.0+Type C Adapter



1. Power adapter is subject to the destination market.
2. For PC without HDMI port but with Type C port, we suggest using Type C-HDMI convertor, but please noted that the Type C has to be USB 3.1 at least.
- 3.As for Type C to HDMI+USB3.0+Type C Adapter,Type C(F) port connected with a charger can supply power to computer or phone which connect with Type C(M) port.(Details refer to Appendix 6.3)

1.2 Product Overview

ASK pro is an intuitive and high efficiency 4K wireless presentation and collaboration system that enables any meeting participant to simply share the content from their laptop, mobile phone, or tablet on the projector or large screen wirelessly, no APP required, no set up, no messy cables, just touch and share.

ASK pro support up to 128 presenters to share their contents instantly without wasting valuable meeting time, also support 4 users in one screen simultaneously, which significantly improves corporate efficiency and productivity.

ASK pro also support Multicast, which is group communication, where video transmission from one transmitter is addressed to a group of receivers simultaneously.

The ASK pro support whiteboard function, user can instantly edit, draw and write on the big screen with touch panel, which is suitable for educational and enterprise application.

A standard ASK pro is a combination of two transmitters and one receiver, the receiver is connected to a projector or big TV, and the transmitters are connected with PC or any device with HDMI jack, after connected, users touch the finger print on the transmitter and the PC screen will

be streaming to the display, other users can switched easily with simple touch. You can buy additional transmitter or receiver if needed.

Never have to worry about the software configuration, no compatibility, WIFI and network set up, no need IT support, with our powerful and simplicity solution, everyone can immediately know how to use it for collaborative presentations.

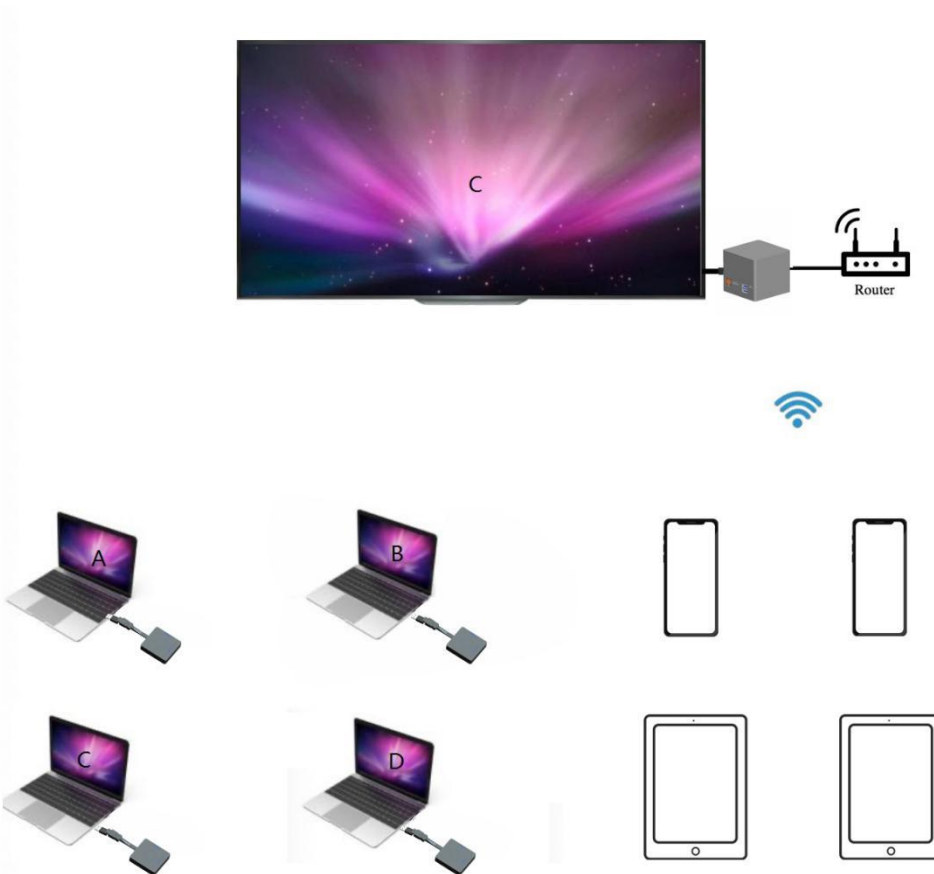

ASK pro System Connection Diagram

Product features

Features	Description
Plug and play	Simple connect the transmitter with your PC USB and HDMI ports, then touch the finger print to start the streaming.
App Free	ASK pro doesn't need any software or app installation, no setup, no IT



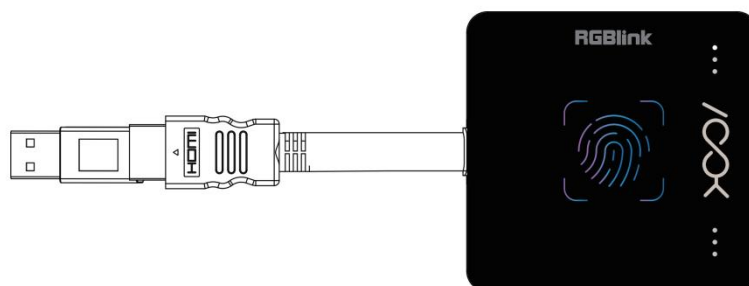

	team.
All in one	Support iOS/Android/Windows system, support Blu-ray DVD player, media player and any devices with HDMI jack.
Touch Control	ASK pro support touch back control function when connect with a big screen with touch panel.
Wireless Camera	Share the images and audio from smart-phone camera or to the large display simultaneous.
Four Screen Split	Up to 128 user's presentation at one time Support up to 4 users on-screen simultaneously
Multicast/ Display Group	Beside one to one streaming mode, ASK pro also support Multicast, which is group communication, where video transmission from one transmitter is addressed to a group of receivers simultaneously
White Board Function	The ASK pro support instantly edit, draw and write on the big screen with touch panel.
Auto Channel Selection	The ASK pro will select the best Wi-Fi channel automatically after power on to ensure streaming smoothly.
Fast Speed with 5G AC MIMO Technology	The ASK pro comes with the fast 802.11ac MIMO technology which increase Wi-Fi speeds by allowing a pair of wireless devices to simultaneously send or receive multiple data streams.
4K60 High Video Quality	ASK pro support real 4K60 decode, which means much more clear pictures, rich in details and texture, the device also supports high dynamic range (HDR).
High Security Protection	No worries about the data security, the ASK pro support AES 128-bit security encryption and WPA2/WPA-PSK/WPA2-PSK authentication protocol to protect data. HDCP supported to protect the content.

1.2.1 Interface

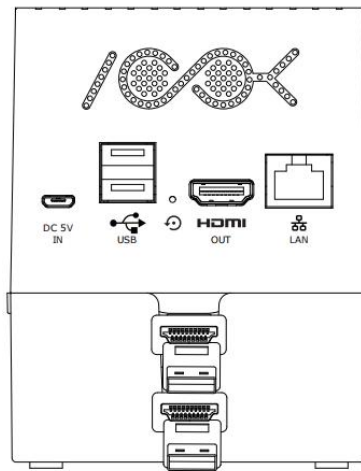

TX Illumination			
Fingerprint key	Touch and it vibrate press to start presenting	HDMI cable	connect computer or other devices with HDMI
USB cable	connect to a computer or other devices for power	LED indicator on present key	to display different statue



RX Illumination			
	reset the device if the device stops working	 DC 5V IN	Micro USB Power DC 5V
	Connect to TV, projector, and monitor by using the HDMI cable.	 LAN	LAN Port, Connect to router for internet access.
	USB 2.0, connect to mouse or U disk	Strap	Strap at the bottom to fix RX

Chapter 2 Install Your Product

2.1 Receiver Installation



1. Power on the RX and connect to the big screen TV or projector by HDMI cable.
2. Connect the USB port to keyboard or mouse to control and screen.
3. Connect RJ45 cable to your RX to access the internet.

Remark:

Please ignore step 3 if no need to access the internet.

2.2 Transmitter Installation



1. Connect the ASK pro TX's HDMI and USB jacks to the laptop USB/HDMI inputs.
2. The LED indicator of the ASK pro TX will light on in green when it's booting up.
3. The LED indicator become purple and flashing when ASK pro is ready to stream.
4. Touch the finger print to start presenting and the LED indicator become static Purple, meaning the casting is successful.

2.3 Pairing of TX and RX

On delivery, each ASK pro set has been paired, but when extra TX are required, following steps are the method for users to finish TX/RX pairing.

A. Connect the RX to the power supply and HDMI port to display, connect USB cable on TX to USB-A port on RX, and the indicator light up in green on the TX.



B. Wait till the LED indicator turn to purple indicating pairing successful.



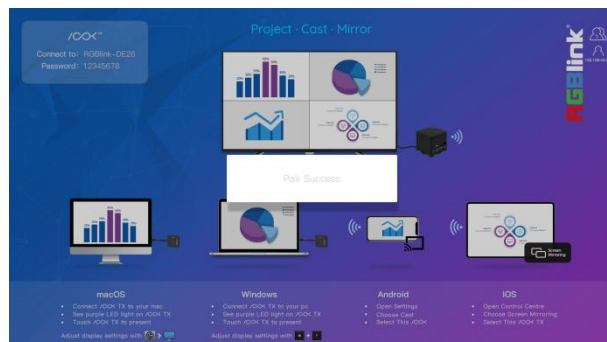

C. "Pair Success" will be displayed on the screen.

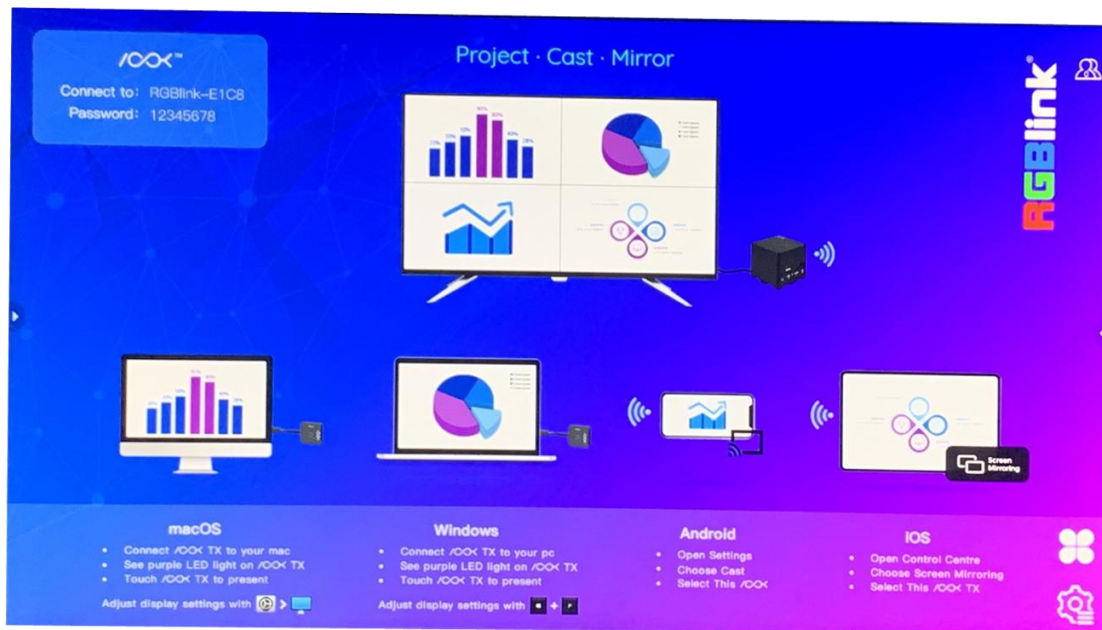

Chapter 3 Use Your Product

3.1 MENU



After RX is connected to big screen, the screen enters homepage, which will be set in English by default. If you need to change the Chinese homepage, click  Settings menu in the lower right corner, and switch the language in common setup.

3.1.1 Setting

Click the Settings icon  for Common Setup, Display Group Setup and Advance Setup.

Common Setup

Language: Switch the Chinese or English menu

Start Animation: Select Animation 1 or 2

Standby Picture: Picture 1 in English, Picture 2 in Chinese

Version: The current version of RX and TX

Certification Status: Activated

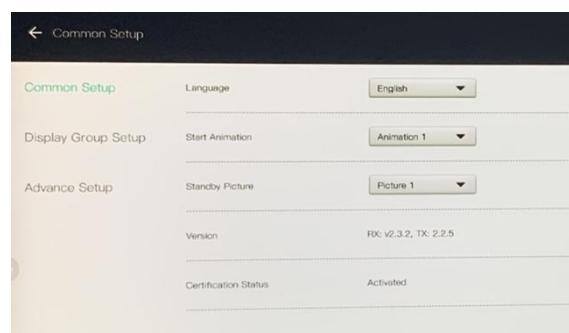

Display Group Setup

Display group switch: when more than one RX is connected to the same LAN, turn on the display group switch to cast the screen of the current RX to the next RX. If the current RX is in the Display Group Setup menu page, then the next RX is also displaying Display Group Setup page.

Valid for screen sharing only: When turned on, the screen will only be cast to the next RX screen if there is a projection screen on current RX screen.

Device List: The RX list in the current LAN.

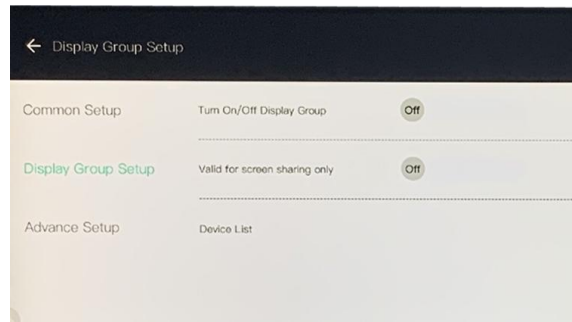

WIFI password: eight digit numbers or letters.

Poweroff reset setup: set the daily switch time.

Multiple TX management: When turned on, the TX list appears at the top right of

the screen .

Iphone video quality: adjust Iphone projection quality from middle to high.

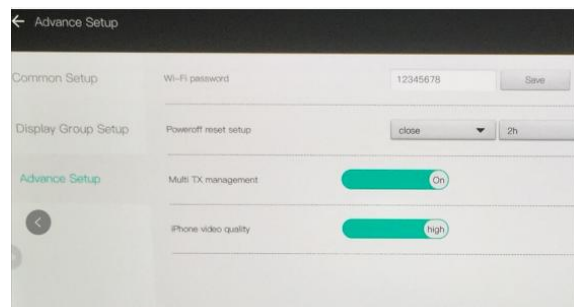

3.1.2 Whiteboard

When RX is connected to the big screen, click the triangle icon on either side of the screen to open the Whiteboard menu. If users use the touch screen, it is suggested to move the triangle icon up or down to avoid conflicts with the menu of the touch screen itself.

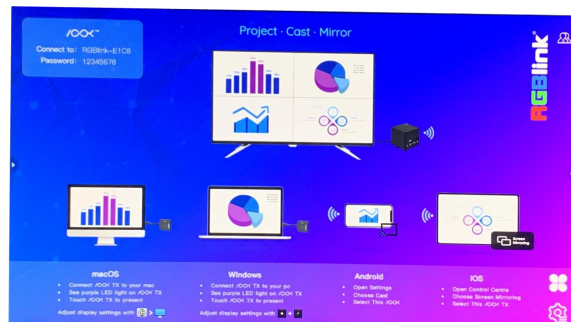





Whiteboard menu

Click the pencil icon to open the Whiteboard interface.

 : Delete

 : Erase

 : The brush can select shape

 : Color palette:select background color

 : Last step

 : Next step

 : Expand the submenus

 : Save as an image

 : Save as a document

 : Open the saved images

 : Open the saved documents

 : Double-click to return the homepage

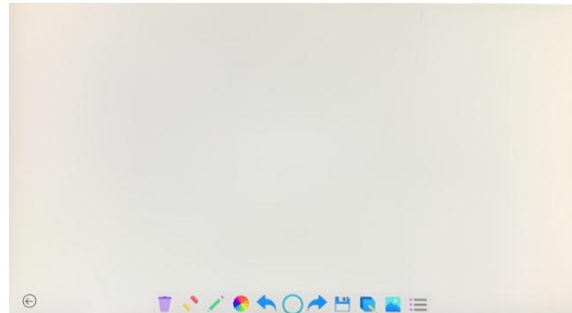

3.1.3 My Apps

Click  to open my app interface

The icons of video player and explorer in my app can also be moved.

Video :Insert the USB into the RX USB-A interface. If there are video files on the USB , you can view them and play them through the video player.

If there are USB plugging into RX, you can see two folders in File Explorer: Internal Storage and USB. Files in the USB can be copied from the RX for viewing through resource management, or copies of images or documents stored on the RX can be moved to the USB for storage.

Tap and hold on a file with left mouse button, the operation menu will be opened ,including Copy, Delete, Move, Paste, Rename. Double-clicking a file with the left mouse button opens a menu of "Open mode", such as "Media Center" and "Video ".

Right-click to return to the previous menu.

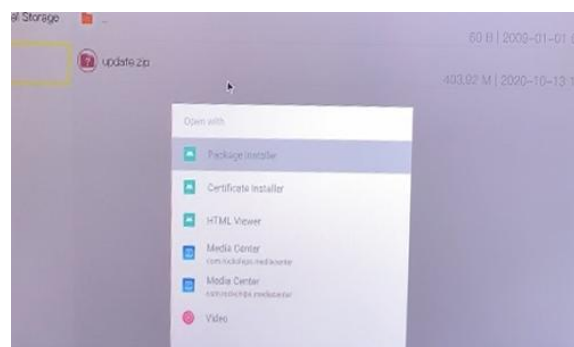
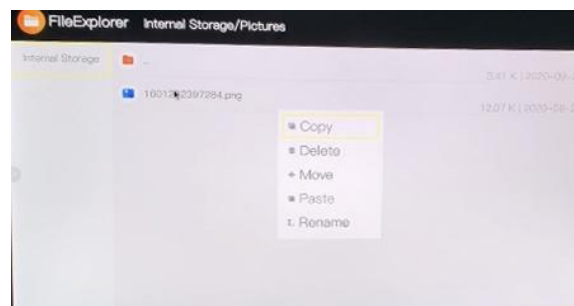
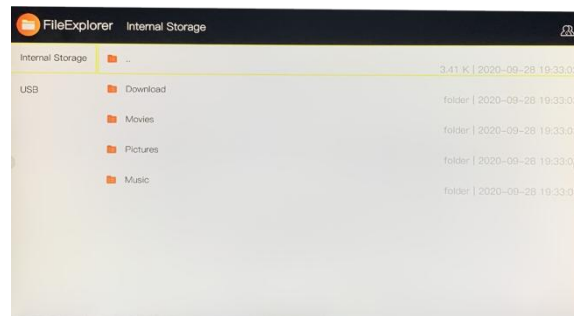
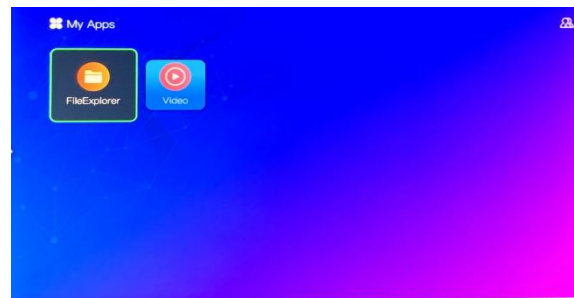

3.2 Computer Screen Projection by TX

For devices using TX projection, mouse back control via RX is supported, provided that the device system meets at least the following conditions: macOS version 10.15.6 or above, and Windows version 7 or 10.

Connecting the above version of the computer to the TX, TX end HDMI to computer HDMI port, and USB to computer USB port .

When TX is powered on, the indicator light changes from green to purple. Touch the fingerprint key to feel the vibration, and the screen of the computer will be projected onto the screen of RX

terminal. The mouse connected to the RX side can control the COMPUTER on the TX side, but it no longer controls the menu on the RX side.

3.3 Phone Screen Projection via RX Hotspot

Smartphones (Apple/Android)

IOS requires version 12.4.8 and above, and Android requires version 9.0 and above.

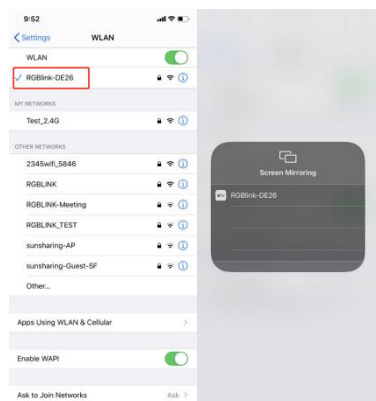

Apple

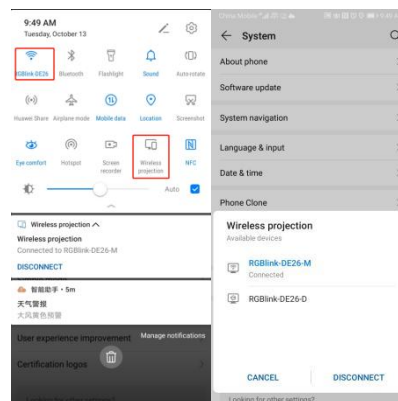

Android

Step 1: Search RX's own hotspot in Settings. The WIFI connection is usually named RGBlink-XXXX, and the initial password is 12345678 or check the password displayed on the standby interface of RX.

Step 2: Turn on the screen projection in general Settings. For example, Apple uses "screen mirroring" and Android "wireless projection".

3.3 Screen Mode

1. Single screen mode:

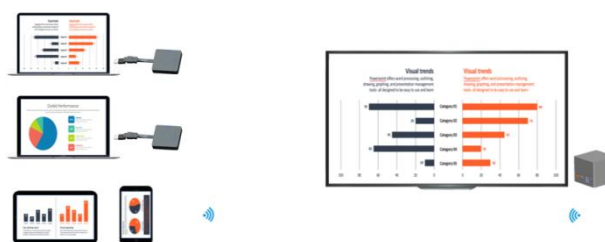

If there is one ASK pro TX, touch the TX finger print shortly, TX vibrates and the image of the laptop will be streaming to the big screen.

If there is two or more ASK pro TX, touch the second TX finger print shortly, the image of the second laptop will automatically replace the image from the first TX.

If you use a smartphone, please stream the content to the big screen by Airplay, miracast and DLNA directly.

2. Multiple Screen Split Mode:



Please touch the ASK pro TX finger print above 2 seconds and there are interval vibrations on TX, then multiple screens can be cast and split to the large display automatically.

If you use smartphone, please ensure that your smart-phone and receiver are connected in the same subnet, click the smart-phone, multiple screens can be cast and split to the large display automatically.

To make sure the multiple screen works there must be at least one TX in the devices about to cast.

When there 3 phones or pad and 1 TX device, streaming from phone or pad first and then long pressing TX finger print to make the screen split, at last cast the other 2 phones or pads, the other 2 screen will be splitted automatically.

Remark: the Android phone don't support multi-screen mode.

3. Exit multiple screens split mode:

You can touch any TX finger print shortly and the image from this TX cast to the screen, other TXs will stop casting.

Or user can click the "Full Screen" icon at the bottom right corner on any image to cover the whole screen but other images are still on casting, they can be retrieved by clicking the "Full Screen" icon again.

3.4 Multicast or Display Group Setup

Step 1: Make sure the different receivers in the same subnet.

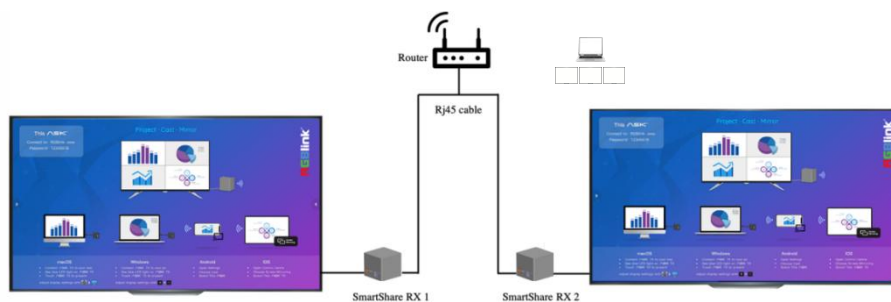

Step 2: Open up the menu on the

homepage and click Setting icon  and open Display Group Setup

Step 3 :Turn on the display group switch, and select the display group you need from the Device List.

If “Valid for screen sharing only” is turned on, the added display group can only share the casted screen on first RX.

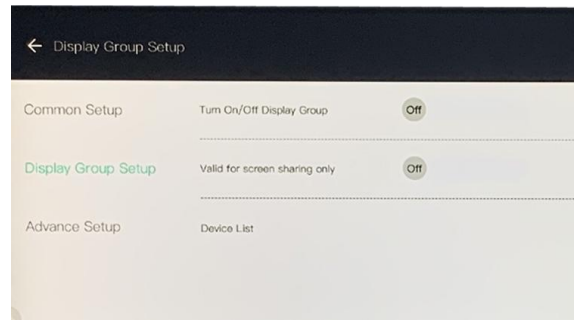

Step 4: After confirmation, the image will stream to the selected receiver automatically, the ASK pro can support up to 8 different receivers.



Chapter 4 Order Codes

Product Code	Item
450-0001-01-0	ASK mini (RX)
450-0101-01-0	ASK me (TX)
450-1001-01-0	ASK pro Meet Set (TX*2+ RX*1)
450-1001-02-0	ASK pro Starter Set(TX*1+RX*1)

Chapter 5 Support

5.1 Contact Us

www.rgblink.com



Inquiries

+86-592-577-1197
info@rgblink.com
rgblink.com/contact-us

Global Support

support@rgblink.com
rgblink.com/support-me



@RGLINK



/rgblink



+rgblink



/rgblink



rgblink



rgblink

RGblink Headquarters

Xiamen, China

Room 601A, No. 37-3
Banshang community,
Building 3, Xinke Plaza, Torch
Hi-Tech Industrial
Development Zone, Xiamen,
China

+86-592-577-1197

China Regional Sales & Support

Shenzhen, China

11th Floor Baiwang Building
5318 Shahe West Road
Baimang, Nanshan

+86-755 2153 5149

Beijing Region Office

Beijing, China

Building 8, 25 Qixiao Road
Shahe Town Changping

+010- 8577 7286

Europe Regional Sales & Support

Eindhoven, Holland

Flight Forum Eindhoven
5657 DW

+31 (040) 202 71 83

Chapter 6 Appendix

6.1 FAQ

1. How to project when I use a MAC that only has Type-c interface ?

A: There is a Type-c Adapter packaged with the device.

2. Should TX and RX be powered on?

A: Yes,both.

3. How to operate multi screen split mode quickly?

A: Multi-screen project devices must have at least one TX signal, TX first, then the phone or other TX.Please note that only iPhone supports multi screen projection while Android phone does not support.Android phone will replace the screen of other device when projecting.

4. How to switch language between Chinese and English?

A: Set in ASK pro homepage: Set in the down right corner->Common Setup->select language

5. Should TX and RX be re-paired when you receive the device?

A: TX and RX are both paired before delivery. If you order extra TX,TX and RX should be paired by yourselves.Steps as follows:Power on RX->Connect TX's USB port to RX's USB-A port->The light on TX turns from green to purple,which means a successful pair.

6. What if phone projection does not work?

A: First exit TX projection,and touch phone projection again

7. What if yellow screen problem is happening ?

A: The problem is solved when upgrading firmware V2.3.6.0 or later version.

8. Whether ASK pro support audio output or not?

A: ASK pro supports audio and video output.If there is no audio output please check the monitor sound setting.

9. What device does ASK pro support?

A :WINDOWS computer/MAC computer/Android phone/iPhone/ipad/camera and so on.

6.2 Connection Supplement

When you connecting TX, please pay attention to following 6 cases, which may result in connection and projection failure.

Case 1: Plug and hang TX to PC directly, as shown in the right picture.

Correct way: You can raise TX with a object to the same height with the connectors of PC to avoid TX dangling or cable twisting.



Case 2: Plug and hang TX to the camera, as shown in the right picture.

Correct way: You can bind TX and camera with wires to avoid TX dangling and cable twisting.



Case 3: The connectors of laptop is on the side of the screen, as shown in the right picture.

Correct way: You can raise TX with a object to the same height with the connectors of laptop to avoid TX dangling or cable twisting.



Case 4: The laptop is heightened by a cooling pad,causing TX dangling as shown in the right picture.

Correct way: You can raise TX with a object to the same height with the connectors of laptop to avoid TX dangling or cable twisting.



Case 5: There is no USB connector in the laptop or the power supply of USB connectors is unstable, as shown in the right picture.

Correct way: You can use HDMI+USB to Type C Adapter to connect TX and your laptop,so as to avoid cable twisting.



Case 6: The laptop has a cooling function with its unique form,as shown in the right picture.

Correct way: You can raise TX with a object to the same height with the connectors of laptop to avoid TX dangling or cable twisting.



6.3 Accessory Supplement



As shown in the picture above, Type C(F) port connected with a charger can supply power to computer or phone which connect with Type C(M) port.

6.4 Specification

Receiver

Connectors	Output	HDMI 2.0	1×HDMI-A
	Communication	LAN	1×RJ45
		USB	2×USB-A
Power	USB	1×micro USB	
Performance	Output Resolutions	HDMI	<i>Subject to native resolution of display connected</i>
		VESA	1280×720@60 1920×1080@60 3840×2160@60
	Supported Standards	HDMI	2.0
Power	Input Voltage	DC 5V 2A	
	Max Power	RX ≤10W	
Environment	Temperature	-0℃ ~ 70℃	
	Humidity	10%~85%	
Physical	Weight	Net	0.2kg
		Packaged	0.8kg (Set with 2 TX)
	Dimension	Net	85mm×85mm×7.5mm
		Packaged	158mm×123mm×190mm (Set with 2 TX)

Transmitter

Connectors	Input	HDMI 1.3 (on cable)	1×HDMI-A
	Power	USB (on cable)	1×USB-A
Performance	Output Resolutions	HDMI	
		VESA	800×600@60 1024×768@60 1280×720@60 1280×800@60

		1280×960@60 1280×1024@60 1400×1050@60 1600×1200@60 1920×1080@60	
	Supported Standards	HDMI 1.3	
Power	Input Voltage	DC 5V 2A	
	Max Power	RX ≤2.5W	
Environment	Temperature	-0℃~70℃	
	Humidity	10%~85%	
Physical	Weight	Net	0.1kg
		Packaged	0.8kg (Set with 2 TX)
	Dimension	Net	70mm×73mm×16mm (without cable)
		Packaged	158mm×123mm×190mm (Set with 2 TX)

6.5 OpenAPI

RGBlink supports API based on request. Please contact our customer service team for API document if you need.

6.6 Terms & Definitions

- RCA**: Connector used primarily in consumer AV equipment for both audio and video. The RCA connector was developed by the Radio Corporation of America.
- BNC**: Stands for Bayonet Neill-Concelman. A cable connector used extensively in television (named for its inventors). A cylindrical bayonet connector that operates with a twist-locking motion .
- CVBS**: CVBS or Composite video, is an analog video signal without audio. Most commonly CVBS is used for transmission of standard definition signals. In consumer applications the connector is typically RCA type, while in professional applications the connector is BNC type.
- YPbPr**: Used to describe the colour space for progressive-scan. Otherwise known as component video.
- VGA**: Video Graphics Array. VGA is an analog signal typically used on earlier computers. The signal is non-interlaced in modes 1, 2, and 3 and interlaced when using in mode
- DVI** : Digital Visual Interface. The digital video connectivity standard that was developed by DDWG (Digital Display Work Group). This connection standard offers two different connectors: one with 24 pins that handles digital video signals only, and one with 29 pins that handles both

digital and analog video.

● **SDI:** Serial Digital Interface. Standard definition video is carried on this 270 Mbps data transfer rate. Video pixels are characterized with a 10-bit depth and 4:2:2 color quantization. Ancillary data is included on this interface and typically includes audio or other metadata. Up to sixteen audio channels can be transmitted. Audio is organised into blocks of 4 stereo pairs. Connector is BNC.

● **HD-SDI:** high-definition serial digital interface (HD-SDI), is standardized in SMPTE 292M this provides a nominal data rate of 1.485 Gbit/s.

● **3G-SDI:** standardized in SMPTE 424M, consists of a single 2.970 Gbit/s serial link that allows replacing dual link HD-SDI.

● **6G-SDI:** standardized in SMPTE ST-2081 released in 2015, 6Gbit/s bitrate and able to support 2160p@30.

● **12G-SDI:** standardized in SMPTE ST-2082 released in 2015, 12Gbit/s bitrate and able to support 2160p@60.

● **U-SDI:** Technology for transmitting large-volume 8K signals over a single cable. a signal interface called the ultra high definition signal/data interface (U-SDI) for transmitting 4K and 8K signals using a single optical cable. The interface was standardized as the SMPTE ST 2036-4.

● **HDMI :** High Definition Multimedia Interface: An interface used for the transmission of uncompressed high definition video, up to 8 channels of audio, and control signals, over a single cable.

● **HDMI 1.3:** released on June 22 2006, and increased the maximum TMDS clock to 340 MHz (10.2 Gbit/s). Support resolution 1920 × 1080 at 120 Hz or 2560 × 1440 at 60 Hz). It added support for 10 bpc, 12 bpc, and 16 bpc color depth (30, 36, and 48 bit/px), called deep color.

● **HDMI 1.4 :** released on June 5, 2009, added support for 4096 × 2160 at 24 Hz, 3840 × 2160 at 24, 25, and 30 Hz, and 1920 × 1080 at 120 Hz. Compared to HDMI 1.3, 3 more features added which are HDMI Ethernet Channel (HEC) , audio return channel (ARC), 3D Over HDMI, a new Micro HDMI Connector, an expanded set of color spaces.

● **HDMI 2.0,** released on September 4, 2013 increases the maximum bandwidth to 18.0 Gbit/s. Other features of HDMI 2.0 include up to 32 audio channels, up to 1536 kHz audio sample frequency, the HE-AAC and DRA audio standards, improved 3D capability, and additional CEC functions.

● **HDMI 2.0a:** was released on April 8, 2015, and added support for High Dynamic Range (HDR) video with static metadata.

● **HDMI 2.0b:** was released March, 2016, support for HDR Video transport and extends the static metadata signaling to include Hybrid Log-Gamma (HLG).

- **HDMI 2.1** : released on November 28, 2017. It adds support for higher resolutions and higher refresh rates, Dynamic HDR including 4K 120 Hz and 8K 120 Hz.

- **DisplayPort**: A VESA standard interface primarily for video, but also for audio, USB and other data. DisplayPort (orDP) is backwards compatible with HDMI, DVI and VGA.

- **DP 1.1**: was ratified on 2 April 2007, and version 1.1a was ratified on 11 January 2008. DisplayPort 1.1 allow a maximum bandwidth of 10.8 Gbit/s (8.64 Gbit/s data rate) over a standard 4-lane main link, enough to support 1920x1080@60Hz

- **DP 1.2**: introduced on 7 January 2010, effective bandwidth to 17.28 Gbit/s support increased resolutions, higher refresh rates, and greater color depth, maximum resolution 3840 × 2160@60Hz

- **DP 1.4**: publish on 1 Mar, 2016. overall transmission bandwidth 32.4 Gbit/s ,DisplayPort 1.4 adds support for Display Stream Compression 1.2 (DSC), DSC is a "visually lossless" encoding technique with up to a 3:1 compression ratio. Using DSC with HBR3 transmission rates, DisplayPort 1.4 can support 8K UHD (7680 × 4320) at 60 Hz or 4K UHD (3840 × 2160) at 120 Hz with 30 bit/px RGB color and HDR. 4K at 60 Hz 30 bit/px RGB/HDR can be achieved without the need for DSC.

- **Multi-mode Fiber**: Fibers that support many propagation paths or transverse modes are called multi-mode fibers, generally have a wider core diameter and are used for short-distance communication links and for applications where high power must be transmitted.

- **Single-mode Fiber**: Fiber that support a single mode are called single-mode fibers. Single-mode fibers are used for most communication links longer than 1,000 meters (3,300 ft).

- **SFP**: small form-factor pluggable , is a compact, hot-pluggable network interface module used for both telecommunication and data communications applications.

- **optical fiber connector**: terminates the end of an optical fiber, and enables quicker connection and disconnection than splicing. The connectors mechanically couple and align the cores of fibers so light can pass. 4 most common types of optical fiber connectors are SC, FC, LC,ST.

- **SC**:(Subscriber Connector), also known as the square connector was also created by the Japanese company – Nippon Telegraph and Telephone. SC is a push-pull coupling type of connector and has a 2.5mm diameter. Nowadays, it is used mostly in single mode fiber optic patch cords, analog, GBIC, and CATV. SC is one of the most popular options, as its simplicity in design comes along with great durability and affordable prices.

- **LC**: (Lucent Connector) is a small factor connector (uses only a 1.25mm ferrule diameter) that has a snap coupling mechanism. Because of its small dimensions, it is the perfect fit for high-density connections, XFP, SFP, and SFP+ transceivers.

- **FC** :(Ferrule Connector) is a screw type connector with a 2.5mm ferrule. FC is a round shaped threaded fiber optic connector, mostly used on Datacom, telecom, measurement equipment,

single-mode laser.

- **ST:** (Straight Tip) was invented by AT&T and uses a bayonet mount along with a long spring-loaded ferrule to support the fiber.











- **USB:** Universal Serial Bus is a standard that was developed in the mid-1990s that defines cables, connectors and communication protocols. This technology is designed to allow a connection, communication and power supply for peripheral devices and computers.

- **USB 1.1:** Full-Bandwidth USB, specification was the first release to be widely adopted by the consumer market. This specification allowed for a maximum bandwidth of 12Mbps.

- **USB 2.0:** or Hi-Speed USB, specification made many improvements over USB 1.1. The main improvement was an increase in bandwidth to a maximum of 480Mbps.

- **USB 3.2:** Super Speed USB with 3 varieties of 3.2 Gen 1 (original name USB 3.0), 3.2 Gen 2 (original name USB 3.1), 3.2 Gen 2x2 (original name USB 3.2) with speed up to 5Gbps, 10Gbps, 20Gbps respectively.

USB version and connectors figure:

	Type A	Type B	Mini A	Mini B	Micro-A	Micro-B	Type C
USB 2.0							
USB 3.0							
USB 3.1&3.2							

- **NTSC :** The colour video standard used in North America and some other parts of the world created by the National Television Standards Committee in the 1950s. NTSC utilizes an interlaced video signals.

- **PAL:** Phase Alternate Line. A television standard in which the phase of the colour carrier is alternated from line to line. It takes four full images (8 fields) for the colour-to-horizontal images (8 fields) for the colour-to-horizontal phase relationship to return to the reference point. This alternation helps cancel out phase errors. For this reason, the hue control is not needed on a PAL TV set. PAL, is widely used in needed on a PAL TV set. PAL, is widely used in Western Europe, Australia, Africa, the Middle East, and Micronesia. PAL uses 625-line, 50-field (25 fps) composite colour transmission system.

- **SMPTE:** Society of Motion image and Television Engineers. A global organization, based in the United States, that sets standards for baseband visual communications. This includes film as well as video and

television standards.

● **VESA:** Video Electronics Standards Association. An organization facilitating computer graphics through standards.

● **HDCP:** High-bandwidth Digital Content Protection (HDCP) was developed by Intel Corporation and is in wide use for protection of video during transmission between devices.

● **HDBaseT:** A video standard for the transmission of uncompressed video (HDMI signals) and related features using Cat 5e/Cat6 cabling infrastructure.

● **ST2110:** A SMPTE developed standard, ST2110 describes how to send digital video over an IP network. Video is transmitted uncompressed with audio and other data in separate streams. SMPTE2110 is intended principally for broadcast production and distribution facilities where quality and flexibility are more important.

● **SDVoE:** Software Defined Video over Ethernet (SDVoE) is a method for transmission, distribution and management of AV signals using a TCP/IP Ethernet infrastructure for transport with low latency. SDVoE is commonly used in integration applications.

● **Dante AV:** The Dante protocol was developed for and widely adopted in audio systems for the transmission of uncompressed digital audio on IP based networks. The more recent Dante AV specification includes support for digital video.

● **NDI:** Network Device interface (NDI) is a software standard developed by NewTek to enable video-compatible products to communicate, deliver, and receive broadcast quality video in a high quality, low latency manner that is frame-accurate and suitable for switching in a live production environment over TCP (UDP) Ethernet based networks. NDI is commonly found in broadcast applications.

● **RTMP:** Real-Time Messaging Protocol (RTMP) was initially a proprietary protocol developed by Macromedia (now Adobe) for streaming audio, video and data over the Internet, between a Flash player and a server.

● **RTSP :** The Real Time Streaming Protocol (RTSP) is a network control protocol designed for use in entertainment and communications systems to control streaming media servers. The protocol is used for establishing and controlling media sessions between end points.

● **MPEG:** Moving Picture Experts Group is a working group formed from ISO and IEC developing standards that allow audio/video digital compression and Transmission.

● **H.264:** Also known as AVC (Advanced Video Coding) or MPEG-4i is a common video compression standard. H.264 was standardized by the ITU-T Video Coding Experts Group (VCEG) together with the ISO/IEC JTC1 Moving Picture Experts Group (MPEG).

● **H.265:** Also known as **HEVC** (High Efficiency Video Coding) H.265 is the successor to the widely used H.264/AVC digital video coding standard. Developed under the auspices of ITU, resolutions up to 8192x4320 may be compressed.

● **API:** An Application Programming Interface (API) provides a predefined function which allows access capabilities and features or routines via a software or hardware, without accessing source code or understanding the details of inner working mechanism. An API call may execute a function and/or provide data feedback/report.

● **DMX512:** The communication standard developed by USITT for entertainment and digital lighting systems. The wide adoption of the Digital Multiplex (DMX) protocol has seen the protocol used for a wide range of other devices including video controllers. DMX512 is delivered over cable of 2 twisted pairs with 5pin XLR cables for connection.

● **ArtNet:** An ethernet protocol based on TCP/IP protocol stack, mainly used in entertainment/events applications. Built on the DMX512 data format, ArtNet enables multiple “universes” of DMX512 to be transmitted using ethernet networks for transport.

● **MIDI:** MIDI is the abbreviation of Musical Instrument Digital Interface. As the name indicates the protocol was developed for communication between electronic musical instruments and latterly computers. MIDI instructions are triggers or commands sent over twisted pair cables, typically using 5pin DIN connectors.

● **OSC:** The principle of Open Sound Control (OSC) protocol is for networking sound synthesizers, computers, and multimedia devices for musical performance or show control. As with XML and JSON, the OSC protocol allows sharing data. OSC is transported via UDP packets between devices connected on an Ethernet.

● **Brightness:** Usually refers to the amount or intensity of video light produced on a screen without regard to colour. Sometimes called black level.

● **Contrast Ratio:** The ratio of the high light output level divided by the low light output level. In theory, the contrast ratio of the television system should be at least 100:1, if not 300:1. In reality, there are several limitations. Well-controlled viewing conditions should yield a practical contrast ratio of 30:1 to 50:1.

● **Colour Temperature:** The colour quality, expressed in degrees Kelvin (K), of a light source. The higher the colour temperature, the bluer the light. The lower the temperature, the redder the light. Benchmark colour temperature for the A/V industry include 5000°K, 6500°K, and 9000°K.

● **Saturation:** Chroma, Chroma gain. The intensity of the colour, or the extent to which a given colour in any image is free from white. The less white in a colour, the truer the colour or the greater its

saturation. Saturation is the amount of pigment in a colour, and not the intensity.

● **Gamma:** The light output of a CRT is not linear with respect to the voltage input. The difference between what you should have and what is actually output is known as gamma.

● **Frame:** In interlaced video, a frame is one complete image. A video frame is made up of two fields, or two sets of interlaced lines. In a film, a frame is one still image of a series that makes up a motion image.

● **Genlock:** Allows synchronisation of otherwise video devices. A signal generator provides a signal pulses which connected devices can reference. Also see Black Burst and Color Burst.

● **Blackburst:** The video waveform without the video elements. It includes the vertical sync, horizontal sync, and the Chroma burst information. Blackburst is used to synchronize video equipment to align the video output.

● **Colour Burst:** In colour TV systems, a burst of subcarrier frequency located on the back part of the composite video signal. This serves as a colour synchronizing signal to establish a frequency and phase reference for the Chroma signal. Colour burst is 3.58 MHz for NTSC and 4.43 MHz for PAL.

● **Colour Bars:** A standard test pattern of several basic colours (white, yellow, cyan, green, magenta, red, blue, and black) as a reference for system alignment and testing. In NTSC video, the most commonly used colour bars are the SMPTE standard colour bars. In PAL video, the most commonly used colour bars are eight full field bars. On computer monitors the most commonly used colour bars are two rows of reversed colour bars

● **Seamless Switching:** A feature found on many video switchers. This feature causes the switcher to wait until the vertical interval to switch. This avoids a glitch (temporary scrambling) which often is seen when switching between sources.

● **Scaling:** A conversion of a video or computer graphic signal from a starting resolution to a new resolution. Scaling from one resolution to another is typically done to optimize the signal for input to an image processor, transmission path or to improve its quality when presented on a particular display.

● **PIP:** Picture-In-Picture. A small image within a larger image created by scaling down one of image to make it smaller. Other forms of PIP displays include Picture-By-Picture (PBP) and Picture- With-Picture (PWP), which are commonly used with 16:9 aspect display devices. PBP and PWP image formats require a separate scaler for each video window .

● **HDR:** is a high dynamic range (HDR) technique used in imaging and photography to reproduce a greater dynamic range of luminosity than what is possible with standard digital imaging or photographic techniques. The aim is to present a similar range of luminance to that experienced through the human visual system.

●**UHD:** Standing for Ultra High Definition and comprising 4K and 8K television standards with a 16:9 ratio, UHD follows the 2K HDTV standard. A UHD 4K display has a physical resolution of 3840x2160 which is four times the area and twice both the width and height of a HDTV/FullHD (1920x1080) video signal.

●**EDID:** Extended Display Identification Data. EDID is a data structure used to communicate video display information, including native resolution and vertical interval refresh rate requirements, to a source device. The source device will then output the provided EDID data, ensuring proper video image quality.

6.7 Revision History

The table below lists the changes of ASK pro User Manual.

Format	Time	ECO#	Description	Principal
V1.0	2020-7-21	0000#	Release	Fanny
V1.0	2020-9-2	0000#	Revise operation	Fanny
V1.1	2020-10-16	0001#	Revise menu, add upgrade operation	Fanny
V1.2	2021-03-17	0002#	Add one USB cable and one Type C to HDMI Adapter	Sylvia
V1.3	2021-06-08	0003#	Add 6.1 FAQ and	Sylvia
V1.4	2021-06-21	0004#	Add 6.2 Connection Supplement	Sylvia

All information herein is Xiamen RGBlink Science & Technology Co Ltd. excepting noted. RGBlink is a registered trademark of Xiamen RGBlink Science & Technology Co Ltd. While all efforts are made for accuracy at time of printing, we reserve the right to alter otherwise make change without notice. E&OM excepted.