

MSP 217



User Manual

- Manual #: RGB-RD-UM-M217 E001
- Revision: V1.0



MSP 217·User Manual

Thank you for choosing our products!

In order to allow you to learn how to use the DVI Extender quickly, we bring you the detailed user manual. You can read the introduction and directions before using the DVI Extender, please read all the information we provide carefully to use our products correctly.

Copyright

©2015 All rights are reserved by RGBlink.

This document is done independently by Xiamen RGBlink Science & Technology Co.,LTD. No part can be copied, reproduced or translated without permission.

Notice

RGBlink provides this manual “as is” without warranty of any kind, no matter expressed or implied, including but not limited to the implied warranties or merchantability and fitness for a particular purpose. RGBlink may make improvements or changes to the products and the programs described in this publication at any time without notice.

This publication would contain technical inaccuracies or typographical errors. Changes are periodically made to the information in this publication, these changes are incorporated in new editions of this publication.

Federal Communications Commission (FCC) Statement

This equipment has been tested and found to comply with the limits for a class A digital device, pursuant to Part 15 of the FCC rules. These limits are designed to provide reasonable protection against harmful interference when the equipment is operated in a commercial environment. This equipment generates, uses and radiates radio frequency energy and, if not installed or used in accordance with the instruction manual, may cause harmful interference to radio communications. Operation of this equipment in a residential area may cause harmful interference, in which case the user will be responsible for

correcting any interference.

Guarantee and Compensation

RGBlink provides a guarantee related to perfect manufacturing as part of the legally stipulated terms of guarantee. On receipt, the purchaser must immediately inspect all delivered goods for damage incurred during transportation, as well as for material and manufacturing faults. Please complain to RGBlink by written notice.

The period of guarantee begins from the date of transfer of risks, in the case of special systems and software on the date of commissioning, at latest 30 days after the transfer of risks. In the event of justified notice of compliant, RGBlink can repair the fault or provide a replacement at its own discretion within an appropriate period. If this measure proves to be impossible or unsuccessful, the purchaser can demand a reduction in the purchase price or cancellation of the contract. All other claims, in particular those relating to compensation for direct or indirect damage, and also damage attributed to the operation of software as well as to other service provided by RGBlink, being a component of the system or independent service, will be deemed invalid provided the damage is not proven to be attributed to the absence of properties guaranteed in writing or due to the intent or gross negligence or part of RGBlink.

If the purchaser or a third party carries out modifications or repairs on goods delivered by RGBlink, or if the goods are handled incorrectly, in particular if the systems are commissioned operated incorrectly or if, after the transfer of risks, the goods are subject to influences not agreed upon in the contract, all guarantee claims of the purchaser will be rendered invalid. Not included in the guarantee coverage are system failures which are attributed to programs or special electronic circuitry provided by the purchaser, e.g. interfaces. Normal wear as well as normal maintenance are not subject to the guarantee provided by RGBlink either.

The environmental conditions as well as the servicing and maintenance regulations specified in this manual must be complied with the customer.

Trademark

Brand and product names mentioned in this manual may be trademarks, registered trademarks or copyrights of their respective holders. All brand and product names mentioned in this manual serve as comments or examples and are not to be understood as advertising for the products or their manufactures.

Company Address



Xiamen RGBlink Science & Technology Co., Ltd.

Headquarter: S603-604 Weiye Building Torch Hi-Tech Industrial Development Zone Xiamen, Fujian Province, P.R.C

Shenzhen office: Floor 11, A1 Building, Baiwang R&D Building, Shahe West Road, Xili Town, Nanshan District, Shenzhen, Guangdong Province, P.R.C

Beijing office: No. 2702, Sino-Light Building Tower B, Wang-Jing East Road, Chaoyang District, Beijing, P.R.C

Shanghai office: East Building F2, No. 88 Qinjiang Road, Shanghai, P.R.C

- **Tel:** +86-592-5771197
- **Fax:** +86-592-5771202
- **Customer Hotline:** 4008-592-315
- **Websites:**
 - ~ <http://www.rgblink.com>
 - ~ <http://www.rgblink.cn>
- **E-mail:** sales@rgblink.com

Safe Operation Summary

The general safety information in this summary is for operating personnel.

Do Not Remove Covers or Panels

There are no user-serviceable parts within the unit. Removal of the top panel will expose dangerous voltages. To avoid personal injury, do not remove the top panel. Do not operate the unit without the panel installed.

Use the Proper Properly

This product is intended to operate from a power source that will not apply more than 230 volts rms between the supply conductors or between both supply conductor and ground. A protective ground connection by way of grounding conductor in the power cord is essential for safe operation.

Ground the Product Properly

This product is grounded through the grounding conductor of the power cord. To avoid electrical shock, plug the power cord into a properly wired receptacle before connecting to the product input or output terminals. A protective-ground connection by way of the grounding conductor in the power cord is essential for safe operation.

Use the Proper Power Cord

Use only the power cord and connector specified for your product. Use only a power cord that is in good condition. Refer cord and connector changes to qualified service personnel.

Use the Proper Fuse

To avoid fire hazard, use only the fuse having identical type, voltage rating, and current rating characteristics. Refer fuse replacement to qualified service personnel.

Do Not Operate in Explosive Dangerous Atmospheres

To avoid explosion, do not operate this product in an explosive atmosphere.

Terms and Equipment Mark in This Manual



WARNING

Highlight an operating procedure, practice, condition, statement, etc, which, if not strictly observed, could result in injury or death of personnel.

Note

Highlights an essential operating procedure, condition or statement.



CAUTION

The exclamation point within an equilateral triangle is intended to alert the user to the presence of important operating and maintenance (servicing) instructions in the literature accompanying the appliance.

Amendment Record

The table below lists the changes to the DVI Extender User Manual.

Format	Time	ECO#	Description	Principal
1.0	2013-11-01	0000	Release	Peter

CONTENT

CONTENT	8
1. Brief Introduction.....	10
Chapter Structure	11
Manual Usage.....	12
Terms and Definitions	13
System Overview	19
Application Questions	20
2. Hardware Orientation.....	21
In This Chapter	21
MSP 217 TX SDI to Fiber Panel.....	22
1: Power interface	22
2.4.6: Indicator.....	22
3: SDI input interface.....	22
5: USB Interface	22
1: Indicator	23
2: Fiber Output.....	23
MSP 217 RX Fiber to SDI Panel	24
1: Indicator	24
2: Fiber input.....	24
1: Power interface	24

2.4.6: Indicator.....	24
3: SDI output interface	25
5: USB Interface	25
3. Operation Manual.....	26
MSP 217 SDI to Fiber.....	26
MSP 217 Fiber to SDI.....	27
4. Common Questions and Solution.....	28
In This Chapter	28
Power indicator light is off or blinks.....	29
Signal indicator light is off or blinks	29
12V power interface poor contact.....	29
A. Specification	30
B. Contact Information.....	32

1. Brief Introduction

This chapter is designed to introduce you to the MSP 217 User Manual. It covers:

- Chapter Structure
- Manual Usage
- Terms and Definitions
- System Overview
- Application Questions

1. Brief Introduction

Chapter Structure

Chapter Structure

The following chapters provide instructions for all aspects of MSP 217 operations:

Chapter 1 [Brief Introduction](#)

Chapter 2 [Hardware Orientation](#)

Chapter 3 [Operation Manual](#)

Chapter 4 [Common Questions and Solution](#)

Appendix A [Specification](#)

Appendix B [Contact Information](#)

1. Brief Introduction

Manual Usage

Manual Usage

Following are important tips for streamlining your use of this User Manual in its electronic “PDF” form.

Navigation

Use Acrobat Reader’s “bookmarks” to navigate to the desired location. All chapter files have the same bookmark structure for instant navigation to any section. Please note:



- Extensive hyperlinks are provided within the chapters.
- Use Acrobat’s “**Go to Previous View**” and “**Return to next View**” buttons to trace your complete navigational path.



- Use the “**Previous Page**” and “**Next Page**” buttons to go to the previous or next page within a file.
- Use Acrobat’s extensive search capabilities, such as the “**Find**” tool and “**Search Index**” tool to perform comprehensive searches as required.

Catalogue and Index

Use the Table of Contents bookmarks to navigate a desired topic. Click any item to instantly jump to that section of the guide. You can also use the **Index** to jump to specific topics within a chapter. Each page number in the **Index** is a hyperlink.

1. Brief Introduction

Terms and Definitions

Terms and Definitions

The following terms and definitions are used throughout this guide;

- **“ASCII”**: American Standard for Information Interchange. The standard code consisting of 7-bit coded characters (8 bits including parity check) used to exchange information between data processing systems, data communication systems, and associated equipment. The ASCII set contains control characters and graphic characters.
- **“Aspect ratio”**: The relationship of the horizontal dimension to the vertical dimension of an image. In viewing screens, standard TV is 4:3, or 1.33:1; HDTV is 16:9, or 1.78:1. Sometimes the “:1” is implicit, making TV = 1.33 and HDTV = 1.78.
- **“AV”**: Audio visual or audio video.
- A **“Background”** is an unscaled source, typically originating from a computer. A background source appears at the system’s lowest priority — visually in back of all other sources.
- **“Baudrate”**: Named of J.M.E. Baudot, the inventor of the Baudot telegraph code. The number of the electrical oscillations per second, called baud rate. Related to, but not the same as, transfer rate in bits per second (bps).
- **“Blackburst”**: The video waveform without the video elements. It includes the vertical sync, horizontal sync, and the chroma burst information. Blackburst is used to synchronize video equipment to align the video output. One signal is normally used to set up an entire video system or facility. Sometimes it is called House sync.
- **“BNC”**: Bayonet Neill-Concel man. A cable connector used extensively in television and named for its inventors. A cylindrical bayonet connector that operates with a twist-locking motion. To make the connection, align the two curved grooves in the collar of the male connector with the two projections on the outside of the female collar, push, and twist. This allows the connector to lock into place without tools.
- **“Brightness”**: Usually refers to the amount or intensity of video light produced on a screen without regard to color. Sometimes called “black level.”
- **“CAT 5”**: Category 5. Describes the network cabling standard that consists of four unshielded twisted pairs of copper wire terminated by RJ-45 connectors. CAT 5 cabling supports data rates up to 100 Mbps. CAT 5 is based on the EIA/TIA 568 Commercial Building Telecommunications Wiring Standard.
- **“Color bars”**: A standard test pattern of several basic colors (white, yellow, cyan, green, magenta, red, blue, and black) as a reference for system alignment and testing. In NTSC video, the most commonly used color bars are the SMPTE standard color bars. In PAL video, the most commonly used color bars are eight full field bars. In the

1. Brief Introduction

Terms and Definitions

computer, the most commonly used color bars are two rows of reversed color bars.

- **“Color burst”**: In color TV systems, a burst of sub-carrier frequency located on the back porch of the composite video signal. This serves as a color synchronizing signal to establish a frequency and phase reference for the chrome signal. Color burst is 3.58 MHz for NTSC and 4.43 MHz for PAL.
- **“Color temperature”**: The color quality, expressed in degrees Kelvin (K), of a light source. The higher the color temperature, the bluer the light. The lower the temperature, the redder the light. Benchmark color temperature for the A/V industry includes 5000°K, 6500°K, and 9000°K.
- **“Contrast ratio”**: The ratio of the high light output level divided by the low light output level. In theory, the contrast ratio of the television system should be at least 100:1, if not 300:1. In reality, there are several limitations. In the CRT, light from adjacent elements contaminate the area of each element. Room ambient light will contaminate the light emitted from the CRT. Well-controlled viewing conditions should yield a practical contrast ratio of 30:1 to 50:1.
- **“DVI”**: Digital Visual Interface. The digital video connectivity standard that was developed by DDWG (Digital Display Work Group). This connection standard offers two different connectors: one with 24 pins that handles digital video signals only, and one with 29 pins that handles both digital and analog video.
- **“EDID”**: Extended Display Identification Data – EDID is a data structure used to communicate video display information, including native resolution and vertical interval refresh rate requirements, to a source device. The source device will then output the optimal video format for the display based on the provided EDID data, ensuring proper video image quality. This communication takes place over the DDC – Display Data Channel.
- **“Ethernet”**: A Local Area Network (LAN) standard officially known as IEEE 802.3. Ethernet and other LAN technologies are used for interconnecting computers, printers, workstations, terminals, servers, etc. within the same building or campus. Ethernet operates over twisted pair and over coaxial cable at speeds starting at 10Mbps. For LAN interconnectivity, Ethernet is physical link and data link protocol reflecting the two lowest layers of the OSI Reference Model.
- **“Frame”**: In interlaced video, a frame is one complete picture. A video frame is made up of two fields, or two sets of interlaced lines. In a film, a frame is one still picture of a series that makes up a motion picture.
- **“Gamma”**: The light output of a CRT is not linear with respect to the voltage input. The difference between what you should have and what is actually output is known as gamma.
- **“HDMI” - High – Definition Multimedia Interface**: An interface used primarily in consumer electronics for the transmission of uncompressed high definition video, up to 8 channels of audio, and

1. Brief Introduction

Terms and Definitions

control signals, over a single cable. HDMI is the de facto standard for HDTV displays, Blu-ray Disc players, and other HDTV electronics. Introduced in 2003, the HDMI specification has gone through several revisions.

- **“HDSDI”**: The high-definition version of SDI specified in SMPTE-292M. This signal standard transmits audio and video with 10 bit depth and 4:2:2 color quantization over a single coaxial cable with a data rate of 1.485 Gbit/second. Multiple video resolutions exist including progressive 1280x720 and interlaced 1920x1080 resolutions. Up to 32 audio signals are carried in the ancillary data.
- **“JPEG” (Joint photographic Expects Group)**: Commonly used method of lost compression for photographic images using a discreet cosine transfer function. The degree of compression can be adjusted, allowing a selectable tradeoff between storage size and image quality. JPEG typically achieves 10:1 compression with little perceptible loss in image quality. Produces blocking artifacts.
- **“MPEG”**: Motion Picture Expect Group. A standard committee under the auspices of the International Standards Organization working on algorithm standards that allow digital compression, storage and transmission of moving image information such as motion video, CD-quality audio, and control data at CD-ROM bandwidth. The MPEG algorithm provides inter-frame compression of video images and can have an effective compression rate of 100:1 to 200:1.
- **“NTSC”**: The color video standard used in North America and some other parts of the world created by the National Television Standards Committee in the 1950s. A color signal must be compatible with black-and-white TV sets. NTSC utilizes an interlaced video signals, 525 lines of resolution with a refresh rate of 60 fields per second (60 Hz). Each frame is comprised of two fields of 262.5 lines each, running at an effective rate of 30 frames per second.
- **“Operator”**: Refers to the person who uses the system.
- **“PAL”**: Phase Alternate Line. A television standard in which the phase of the color carrier is alternated from line to line. It takes four full pictures (8 fields) for the color-to-horizontal phase relationship to return to the reference point. This alternation helps cancel out phase errors. For this reason, the hue control is not needed on a PAL TV set. PAL, in many transmission forms, is widely used in Western Europe, Australia, Africa, the Middle East, and Micronesia. PAL uses 625-line, 50-filed (25 fps) composite color transmission system.
- **“PIP”**: Picture-in-Picture. A small picture within a larger picture created by scaling down one of the images to make it smaller. Each picture requires a separate video source such as a camera, VCR, or computer. Other forms of PIP displays include Picture-by-Picture (PBP) and Picture-with-Picture (PWP), which are commonly used with 16:9 aspect display devices. PBP and PWP image formats require a separate scaler for each video window.

1. Brief Introduction

Terms and Definitions

- **“Polarity”**: The positive and negative orientation of a signal. Polarity usually refers to the direction or a level with respect to a reference (e.g. positive sync polarity means that sync occurs when the signal is going in the positive direction).
- **“RJ-45”**: Registered Jack-45. A connector similar to a telephone connector that holds up to eight wires used for connecting Ethernet devices.
- **“RS-232”**: An Electronic Industries Association (EIA) serial digital interface standard specifying the characteristics of the communication path between two devices using either DB-9 or DB-25 connectors. This standard is used for relatively short-range communication and does not specify balanced control lines. RS-232 is a serial control standard with a set number of conductors, data rate, word length, and type of connector to be used. The standard specifies component connection standards with regard to the computer interface. It is also called RS-232-C, which is the third version of the RS-232 standard, and is functionally identical to the CCITT V.24 standard.
- **“Saturation”**: Chroma, chroma gain. The intensity of the color, or the extent to which a given color in any image is free from white. The less white in a color, the truer the color or the greater its saturation. On a display device, the color control adjusts the saturation. Not to be confused with the brightness, saturation is the amount of pigment in a color, and not the intensity. Low saturation is like adding white to the color. For example, a low-saturated red looks pink.
- **“Scaling”**: A conversion of a video or computer graphic signal from a starting resolution to a new resolution. Scaling from one resolution to another is typically done to optimize the signal for input to an image processor, transmission path or to improve its quality when presented on a particular display.
- **“SDI”**: Serial Digital Interface. The standard based on a 270 Mbps transfer rate. This is a 10-bit, scrambled, polarity independent interface with common scrambling for both component ITU-R 601 and composite digital video and four channels of (embedded) digital audio.
- **“Seamless Switching”**: A feature found on many video switchers. This feature causes the switcher to wait until the vertical interval to switch. This avoids a glitch (temporary scrambling) which normally is seen when switching between sources.

1. Brief Introduction

Terms and Definitions

- **“SMPTE”**: Society of Motion Picture and Television Engineers. A global organization, based in the United States that sets standards for base band visual communications. This includes film as well as video and television standards.
- **“S-video”**: A composite video signal separated into the luma (“Y” is for luma, or black and white information; brightness) and the chroma (“C” is an abbreviation for chroma, or color information).
- **“Sync”**: Synchronization. In video, sync is a means of controlling the timing of an event with respect to other events. This is accomplished with timing pulses to insure that each step in a process occurs at the correct time. For example, horizontal sync determines exactly when to begin each horizontal scan line. Vertical sync determines when the image is to be refreshed to start a new field or frame. There are many other types of sync in video system.(Also known as “sync signal” or “sync pulse.”)
- **“TCP/IP”**: Transmission Control Protocol/Internet Protocol. The communication protocol of the Internet. Computers and devices with direct access to the Internet are provided with a copy of the TCP/IP program to allow them to send and receive information in an understandable form.
- **“USB”**: Universal Serial Bus. USB was developed by seven PC and telecom industry leaders (Compaq, DEC, IBM, Intel, Microsoft, NEC, and Northern Telecom). The goal was easy plug-and-play expansion outside the box, requiring no additional circuit cards. Up to 127 external computer devices may be added through a USB hub, which may be conveniently located in a keyboard or monitor. USB devices can be attached or detached without removing computer power. The number of devices being designed for USB continues to grow, from keyboards, mice, and printers to scanners, digital cameras, and ZIP drives.
- **“VESA”**: Video Electronics Standards Association. A nonprofit number organization dedicated to facilitating and promoting personal computer graphics through improved standards for the benefit of the end-user. www.vesa.org.
- **“VGA”**: Video Graphics Array. Introduced by IBM in 1987, VGA is an analog signal with TTL level separate horizontal and vertical sync. The video outputs to a 15-pin HD connector and has a horizontal scan

1. Brief Introduction

Terms and Definitions

frequency of 31.5 kHz and vertical frequency of 70 Hz (Mode 1, 2) and 60 Hz (Mode 3). The signal is non-interlaced in modes 1, 2, and 3 and interlaced when using the 8514/A card (35.5 kHz, 86 Hz) in mode 4. It has a pixel by line resolution of 640×480 with a color palette of 16 bits and 256,000 colors.

- **“YCrCb”**: Used to describe the color space for interlaced component video.
- **“YPbPr”**: Used to describe the color space for progressive-scan (non-interlaced) component video.

1. Brief Introduction

System Overview

System Overview

MSP 217 SDI Extender is consisted of SDI transmitter (MSP 217 TX SDI to Fiber) and SDI receiver (MSP 217 RX Fiber to SDI), SDI signal is realized by a single core mode fiber. And SDI digital video signal has to fulfill the long distance transmission during the multimedia application System. But when you use an ordinary cable for long distance transmission, it will always show the poor output signal, be easy of the interference, the mage displayed appears the phenomenon of the vague, the tailing and color separation etc. At the same time, the distance of transmission is short, it can not meet the requirement of long distance transmission for the multimedia information issuing and so on, using the MSP 217 SDI Extender for transmitting, this kind of problem has been completely solved. The distance of transmission is 10km in single mode. In the mean while, the SDI Extender has the outstanding points with a little attenuation, high frequency bandwidth, strong anti-interference, high safety performance, small volume and light in weight etc., therefore, it has incomparable advantages in the respect of the special environment and the long distance transmission. It is used in the multimedia system, which save the construction cost and easy for cable arrangement, and the target of high quality performance is also guaranteed.

MSP 217 TX SDI to Fiber is the transmitter, and MSP 217 RX Fiber to SDI is the receiver, the two devices are used together, it can be realized The long distance transmission of SDI signal by MSP 217 SDI to Fiber With fiber optical cable to MSP 217 Fiber to SDI. This is especially suitable for the high definition video signal transmission in the train platform and the military practice.

1. Brief Introduction

Application Questions

Application Questions

RGBlink offers solutions to demand technical problems. Any application questions, or required further information, please contact with our Customer Support Engineers. Refer to Appendix B for contact details.

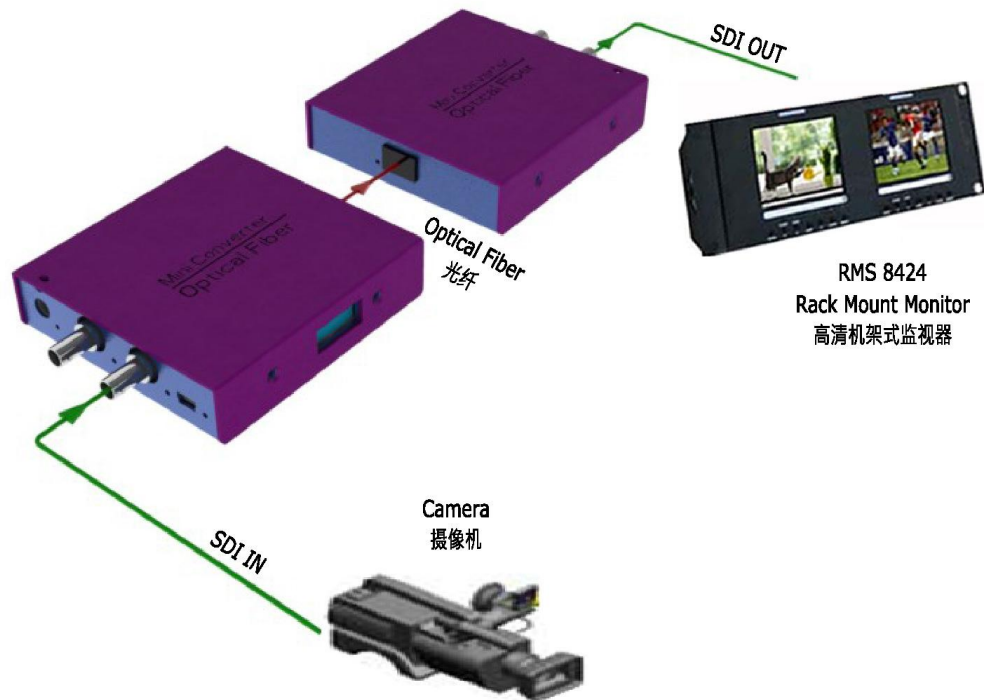

2. Hardware Orientation

In This Chapter

This chapter provides detailed information about the MSP 217 panel. The following topics are discussed:

- [MSP 217 TX SDI to Fiber Panel](#)
- [MSP 217 RX Fiber to SDI Panel](#)

2. Hardware Orientation

MSP 217 TX SDI to Fiber Panel

MSP 217 TX SDI to Fiber Panel

The figure below illustrates the professional interface and control signals of MSP 217 SDI to Fiber panel:

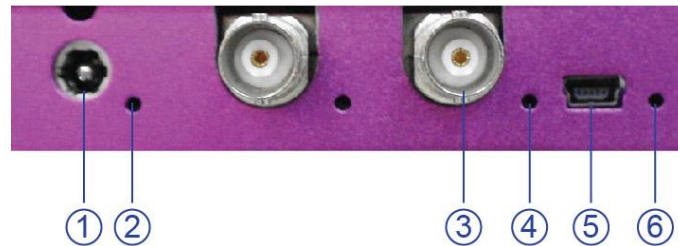

1: Power interface

The device uses the standard 12V/1.5A power supply.

2.4.6: Indicator

Power indicator 2 lights when device has power supply.

LED indicator 4 is on when connect SDI cable and the device is in normal Operation.

LED indicator 6 is on when connect USB cable and the device is in normal Operation.

3: SDI input interface

SDI input interface. Can receive video signal from HD player, and HD camera, connect interface 16 via 75 ohms impedance BNC port. Connect LED screens via network cable.

5: USB Interface

Remote communication device control interface, used to connect to the computer or console.

2. Hardware Orientation

MSP 217 TX SDI to Fiber Panel

The figure below illustrates the professional interface and control signals of MSP 217 SDI to Fiber panel:

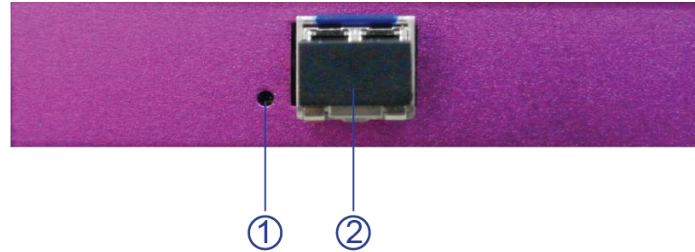

1: Indicator

LED indicator 1 is on when connect fiber cable and the device is in normal operation.

2: Fiber Output

Used to connect fiber cable, the device uses single mode one-core, LC interface.

2. Hardware Orientation

MSP 217 RX Fiber to SDI Panel

MSP 217 RX Fiber to SDI Panel

The figure below illustrates the professional interface and control signals of MSP 217 Fiber to SDI panel:

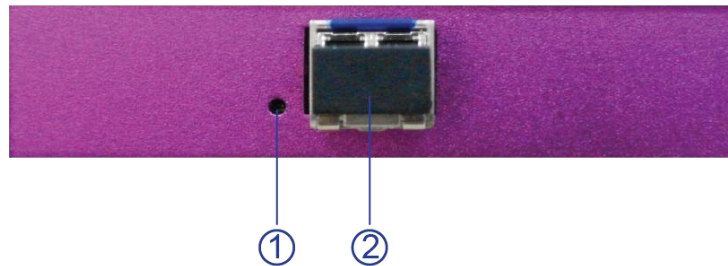

1: Indicator

LED indicator 1 is on when connect fiber cable and the device is in normal operation.

2: Fiber input

Used to connect fiber cable, the device uses single mode one-core, LC interface.

The figure below illustrates the professional interface and control signals of MSP 217 Fiber to SDI panel:

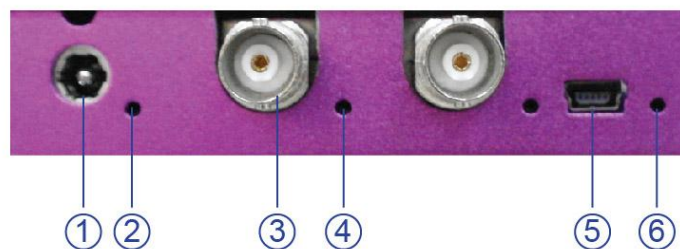

1: Power interface

The device uses the standard 12V/1.5A power supply.

2.4.6: Indicator

2. Hardware Orientation

MSP 217 RX Fiber to SDI Panel

Power indicator 2 lights when device has power supply.

LED indicator 4 is on when connect SDI cable and the device is in normal Operation.

LED indicator 6 is on when connect USB cable and the device is in normal Operation.

3: SDI output interface

SDI input interface, Can receive video signal from HD player, and HD camera, connect interface 16 via 75 ohms impedance BNC port. Connect LED screens via network cable.

5: USB Interface

Remote communication device control interface, used to connect to the computer or console.

3. Operation Manual

MSP 217 SDI to Fiber

Function Block Diagram

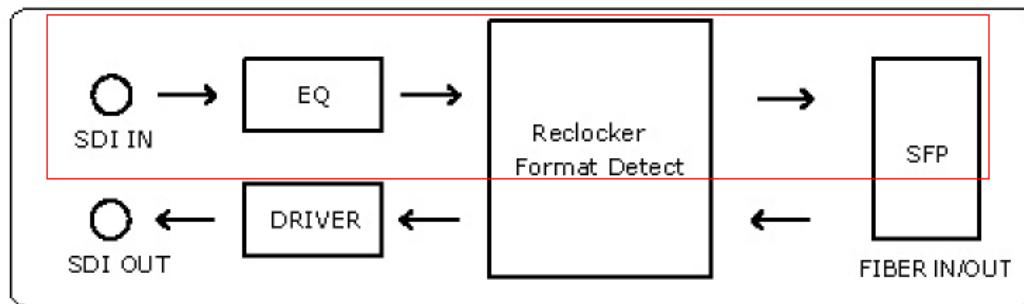

Operating Principle

MSP 217 SDI to Fiber transmitter is connected to media player or HD/SD SDI camera, etc. MSP 217 SDI to Fiber transmitter to power supply.

In order to avoid the damage of device, please use the standard power adapter. Fiber interface is used to connect to MSP 217 Fiber to SDI receiver.

2. Operation Manual

MSP 217 Fiber to SDI

MSP 217 Fiber to SDI

Function Block Diagram

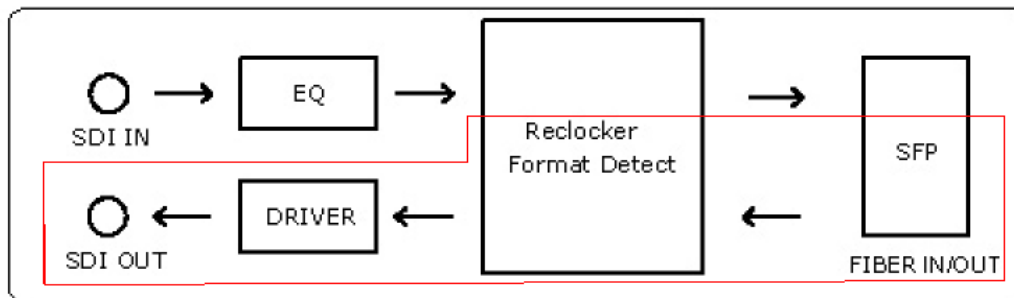

Operating Principle

MSP 217 Fiber to SDI receiver is connected to television (monitor) or other device which has SDI interface.

Connect the fiber interface to the other fiber interface on MSP 217 SDI to Fiber transmitter with fiber cable, and then connect the SDI interface on MSP 217 Fiber to SDI panel to display device.

In order to avoid damaging the device, please use the standard power adapter.

4. Common Questions and Solution

In This Chapter

This chapter provides the common questions and solution for the DVI Extender. The following topics are provided:

- Power indicator light is off or blinks
- Signal indicator light is off or blinks
- 12V power interface poor contact

Power indicator light is off or blinks

1. Check whether plug in the power cord, and has power supply;
2. Check whether the power cable is connected, and in good connection;
3. If above without problem, then the power indicator is damaged.

Signal indicator light is off or blinks

1. Check whether connect the signal;
2. Check whether the input signal, input wire and output wire are normal, the interfaces are in good connection;
3. If above without problem, then the signal indicator is damaged.

Note: The indicator beside fiber interface is on when the device is in normal operation. It will off or blink if the fiber cable is in poor connection.

12V power interface poor contact

1. Check whether the power interface is in good connection, if the interface is not tighten, screw it again.
2. Check whether any problem with adapter head, replace it if there is any problem.
3. Check the power connector is loose, if so, please send to professional personnel for repair.

A. Specification

MSP 217 –TX SDI TO FIBER	
Number of Input	1
Connector	BNC
Number of Output	1
Connector	SFP
Supported Resolution	STMPE: 480i@60Hz,576i@50Hz,720p@23.97Hz,720p@24Hz, 720p@25Hz,720p@29.97Hz,720p@30Hz,720p@50Hz, 720p@59.94Hz,720p@60Hz,1080i@50Hz,1080i@59.94Hz, 1080i@60Hz,1080p@23.97Hz,1080p@24Hz,1080p@25Hz, 1080p@29.97Hz,1080p@30Hz,1080p@50Hz,1080p@59.94Hz, 1080p@60Hz
Format Standard	SMPTE424M,SMPTE 292M,SMPTE 259M
MSP 217-RX FIBER TO SDI	
Number of Input	1
Connector	SFP
Number of Output	1
Connector	BNC
Supported Resolution	STMPE: 480i@60Hz,576i@50Hz,720p@23.97Hz,720p@24Hz, 720p@25Hz,720p@29.97Hz,720p@30Hz,720p@50Hz, 720p@59.94Hz,720p@60Hz,1080i@50Hz,1080i@59.94Hz, 1080i@60Hz,1080p@23.97Hz,1080p@24Hz,1080p@25Hz, 1080p@29.97Hz,1080p@30Hz,1080p@50Hz,1080p@59.94Hz, 1080p@60Hz
SFP+FIBER MODULE	
3 Gigabit single-mode 10 km optical fiber module	
Wavelength of Light Transmission	1310nm
Transmission Rate	3Gbps
Transmission Distance	10km
Transmission	Single mode
Hot Plug	Support
10Gigabit single-mode 10 km optical fiber module	
Wavelength of Light Transmission	1310nm
Transmission Rate	10Gbps
Transmission	10km

Distance	
Transmission	Single mode
Hot Plug	Support
Extras	
Power Supply	12V DC/3A
Working Environment	0°C~70°C
Stored Environment	10%~90%
Dimensions	98mmX92mmX22mm
Product Warranty	3 years parts and labor warranty

B. Contact Information

Warranty:

All video products are designed and tested to the highest quality standard and backed by full 3 years parts and labor warranty. Warranties are effective upon delivery date to customer and are non-transferable. RGBlink warranties are only valid to the original purchase/owner. Warranty related repairs include parts and labor, but do not include faults resulting from user negligence, special modification, lighting strikes, abuse(drop/crush), and/or other unusual damages.

The customer shall pay shipping charges when unit is returned for repair.

Headquarter: S603~604 Weiye Building Torch Hi-Tech Industrial Development Zone Xiamen, Fujian Province, P.R.C

- **Tel:** +86-592-5771197
- **Fax:** +86-592-5771202
- **Customer Hotline:** 4008-592-315
- **Websites:**
 - ~ <http://www.rgblink.com>
 - ~ <http://www.rgblink.cn>
- **E-mail:** support@rgblink.com