

# RGBlink 4K vue PTZ camera

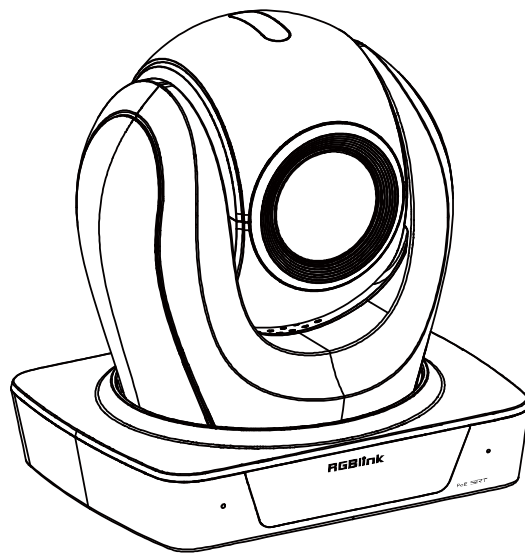

## User Manual

**RGBlink**<sup>®</sup>

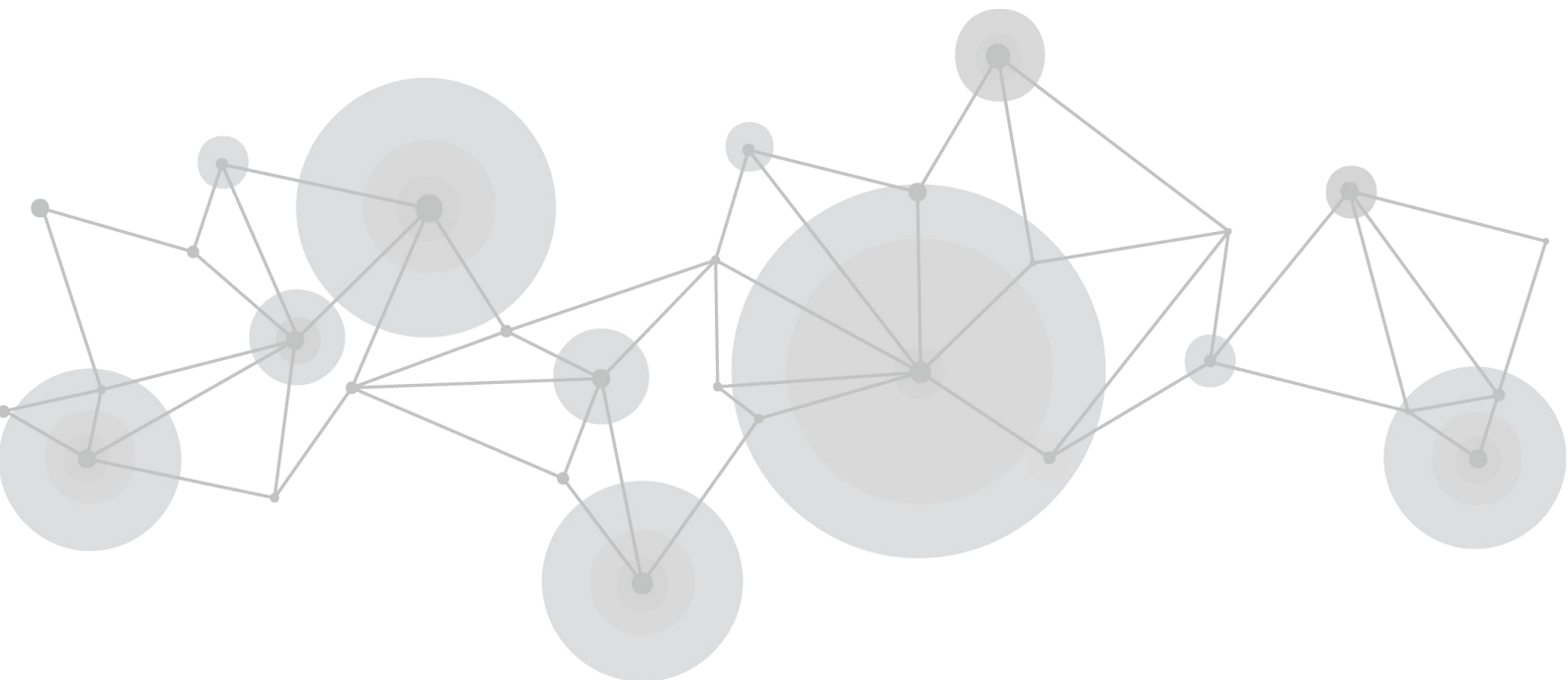

---

# Content

<b>Declarations .....</b>	<b>3</b>
FCC/Warranty .....	3
Operators Safety Summary .....	4
Installation Safety Summary .....	4
<b>Chapter 1 Your Product .....</b>	<b>6</b>
1.1 In the Box .....	6
1.2 Product Overview .....	6
1.2.1 Dimension .....	6
1.2.2 Main Features .....	6
1.2.3 Technical Specification .....	7
<b>Chapter 2 Install Your Product .....</b>	<b>9</b>
2.1 Interface and Switch .....	9
2.2 RS232 Interface .....	10
2.3 Quick Start .....	11
2.4 Installation .....	11
2.4.1 Wall Mount .....	11
2.4.2 Ceiling Mount .....	12
<b>Chapter 3 Use Your Product .....</b>	<b>13</b>
3.1 Remote Controller .....	13
3.2 GUI Settings .....	14
3.2.1 MENU .....	14
3.2.2 EXPOSURE .....	14
3.2.3 COLOR .....	15
3.2.4 IMAGE .....	15
3.2.5 P/T/Z .....	16
3.2.6 NOISE REDUCTION .....	16
3.2.7 SETUP .....	16
3.2.8 COMMUNICATION SETUP .....	17
3.2.9 RESTORE DEFAULT .....	17
3.3 WEB Settings .....	18
3.3.1 Access Camera .....	18
3.3.2 Control Camera .....	18
3.3.3 Video Settings .....	20
3.3.4 Image Settings .....	21
3.3.5 Audio Settings .....	22
3.3.6 System Settings .....	22
3.3.7 Network Settings .....	23
3.3.8 System Settings .....	24
3.3.9 Download Upgrade Program .....	24
<b>Chapter 4 Ordering Codes .....</b>	<b>25</b>

---

4.1 Product Code .....	25
<b>Chapter 5 Support .....</b>	<b>26</b>
5.1 Contact Us .....	26
5.2 Troubleshooting .....	27
<b>Chapter 6 Appendix .....</b>	<b>28</b>
6.1 VISCA Protocol List .....	28
6.2 AI Protocol List .....	33
6.3 Pelco-P Protocol List .....	33
6.4 Pelco-D Protocol List .....	34
6.5 Terms & Definitions .....	34
6.6 Revision History .....	41

Thank you for choosing our product!

This User Manual is designed to show you how to use this PTZ quickly and make use of all the features. Please read all directions and instructions carefully before using this product.

## Declarations

### FCC/Warranty

#### **Federal Communications Commission (FCC) Statement**

This equipment has been tested and found to comply with the limits for a class A digital device, pursuant to Part 15 of the FCC rules. These limits are designed to provide reasonable protection against harmful interference when the equipment is operated in a commercial environment. This equipment generates, uses, and can radiate radio frequency energy and, if not installed and used in accordance with the instruction manual, may cause harmful interference to radio communications. Operation of this equipment in a residential area may cause harmful interference, in which case the user will be responsible for correcting any interference.

#### **Guarantee and Compensation**

RGBlink provides a guarantee relating to perfect manufacturing as part of the legally stipulated terms of guarantee. On receipt, the purchaser must immediately inspect all delivered goods for damage incurred during transport, as well as for material and manufacturing faults. RGBlink must be informed immediately in writing of any complains.

The period of guarantee begins on the date of transfer of risks, in the case of special systems and software on the date of commissioning, at latest 30 days after the transfer of risks. In the event of justified notice of compliant, RGBlink can repair the fault or provide a replacement at its own discretion within an appropriate period. If this measure proves to be impossible or unsuccessful, the purchaser can demand a reduction in the purchase price or cancellation of the contract. All other claims, in particular those relating to compensation for direct or indirect damage, and also damage attributed to the operation of software as well as to other service provided by RGBlink, being a component of the system or independent service, will be deemed invalid provided the damage is not proven to be attributed to the absence of properties guaranteed in writing or due to the intent or gross negligence or part of RGBlink.

If the purchaser or a third party carries out modifications or repairs on goods delivered by RGBlink, or if the goods are handled incorrectly, in particular if the systems are commissioned operated incorrectly or if, after the transfer of risks, the goods are subject to influences not agreed upon in the contract, all guarantee claims of the purchaser will be rendered invalid. Not included in the guarantee coverage are system failures which are attributed to programs or special electronic circuitry provided by the purchaser, e.g. interfaces. Normal wear as well as normal maintenance are not subject to the guarantee provided by RGBlink either.

The environmental conditions as well as the servicing and maintenance regulations specified in this manual must be complied with by the customer.

---

# Operators Safety Summary

The general safety information in this summary is for operating personnel.

## Do Not Remove Covers or Panels

There are no user-serviceable parts within the unit. Removal of the top cover will expose dangerous voltages. To avoid personal injury, do not remove the top cover. Do not operate the unit without the cover installed.

## Power Source

This product is intended to operate from a power source that will not apply more than 230 volts rms between the supply conductors or between both supply conductor and ground. A protective ground connection by way of grounding conductor in the power cord is essential for safe operation.

## Grounding the Product

This product is grounded through the grounding conductor of the power cord. To avoid electrical shock, plug the power cord into a properly wired receptacle before connecting to the product input or output terminals. A protective-ground connection by way of the grounding conductor in the power cord is essential for safe operation.

## Use the Proper Power Cord

Use only the power cord and connector specified for your product. Use only a power cord that is in good condition. Refer cord and connector changes to qualified service personnel.

## Use the Proper Fuse

To avoid fire hazard, use only the fuse having identical type, voltage rating, and current rating characteristics. Refer fuse replacement to qualified service personnel.

## Do Not Operate in Explosive Atmospheres

To avoid explosion, do not operate this product in an explosive atmosphere.

# Installation Safety Summary

## Safety Precautions

For all PTZ installation procedures, please observe the following important safety and handling rules to avoid damage to yourself and the equipment.

To protect users from electric shock, ensure that the chassis connects to earth via the ground wire provided in the AC power Cord.

The AC Socket-outlet should be installed near the equipment and be easily accessible.

## Unpacking and Inspection

Before opening PTZ shipping box, inspect it for damage. If you find any damage, notify the shipping carrier immediately for all claims adjustments. As you open the box, compare its contents against the packing slip. If you

---

find any shortages, contact your sales representative.

Once you have removed all the components from their packaging and checked that all the listed components are present, visually inspect the system to ensure there was no damage during shipping. If there is damage, notify the shipping carrier immediately for all claims adjustments.

## Site Preparation

The environment in which you install your PTZ should be clean, properly lit, free from static, and have adequate power, ventilation, and space for all components.

## Electric Safety

Installation and operation must accord with electric safety standard

## Polarity of power supply

The power supply of the product is  $\pm 12V$ , the max electrical current is 2A .Polarity of the power supply drawing.

## Careful of installation

Never move the camera by seizing the camera head. Don't rotate camera head by hand; otherwise, mechanical trouble will occur.

This series item must be put on the smooth desk or platform, and it can not be installed slant ways;

If the camera is installed on TV or computer, the base can be fixed by four double-sided adhesive trays.

Don't apply in corrosive liquid, as or solid environment to avoid the cover which is made up of organic material.

To make sure no obstacle in rotation range.

Never power on before installation is completed.

## Don't disassemble discretionarily.

We are not responsible for any unauthorized modification or dismantling.

---

# Chapter 1 Your Product

---

## 1.1 In the Box

Name	Qty.
Camera	1
International Power Adapter (cable included )	1
RS232 Cable	1
Remote Control	1
User Manual	1

## 1.2 Product Overview

### 1.2.1 Dimension

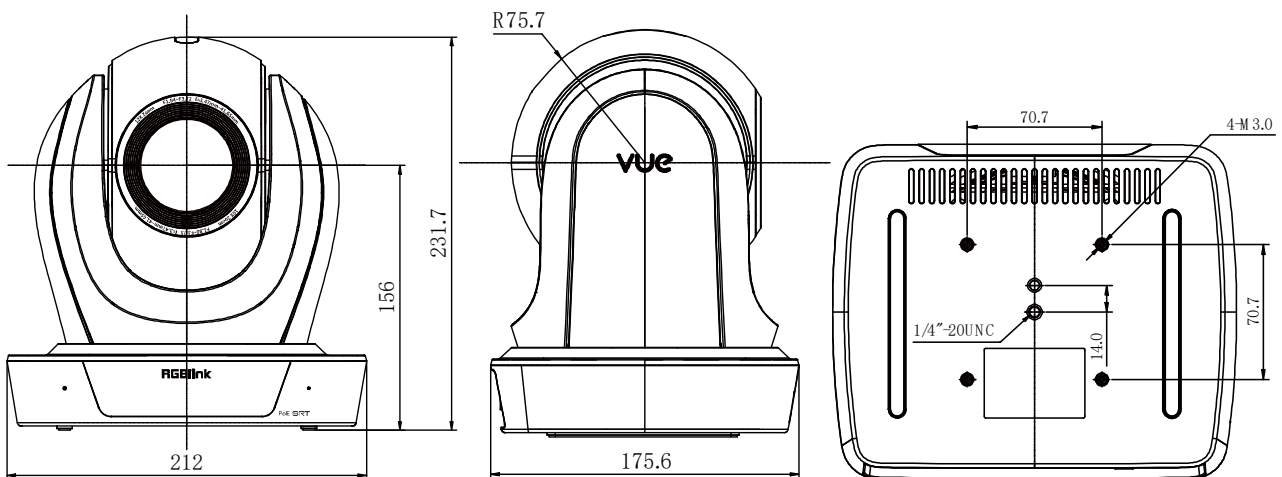

unit:mm

### 1.2.2 Main Features

- **AI Tracking:** With the help of the AI computing power of the chip, the camera is equipped with advanced AI algorithms to realize humanoid tracking, which can realize automatic tracking of scenes such as education, conferences and live broadcasts.
- **NDI|HX2 (Optional):** NDI|HX2 has the characteristics of low delay and plug and play, which is convenient for project implementation and deployment. It has good ecology and supports the simultaneous transmission of audio, video and control commands. It is a new generation of network video transmission mode.
- **4K UHD:** 12X adapts 1/2.8-inch high-quality UHD CMOS sensor with a maximum of 8.46 million effective pixels, 20X adapts 1/1.8-inch high-quality UHD CMOS sensor with a maximum of 8.42 million effective pixels

can realize 4K (3840x2160) ultra-high-resolution high-quality images. And downward compatible with 1080p, 720p and other resolutions.

- **16X Optical Zoom:** It adopts 4K ultra long focal lens with high quality and 8.46 million ultra-high resolution, 16x optical zoom, and the maximum field angle is 80.8° .
- **12G-SDI:** The maximum support is 2160P60 YUV422 10BIT video output, and 12G-SDI can solve the problem of 4K long-distance transmission with one cable.
- **HDMI 2.0:** Support HDMI 2.0 interface, which can directly output 4KP60 uncompressed digital video.
- **Low Light:** The application of 3D noise reduction algorithm greatly reduces image noise. Even under the condition of ultra-low illumination, it still keep the picture clean and clear, and the SNR of image is as high as 55dB.
- **Multiple Interfaces:** Support HDMI 2.0 and 12G-SDI HD output interfaces. HDMI, 12G-SDI, USB, and LAN can simultaneously output four HD digital signals.
- **Multiple Control Methods:** The camera can be controlled using RS232, RS422/RS485, network, and USB.
- **Gravity Sensor:** It supports automatic image flipping function, which is convenient for engineering installation and use.

### 1.2.3 Technical Specification

Model	12X	20X
<b>Camera Parameters</b>		
<b>Sensor</b>	1/2.8 inch, CMOS	1/1.8 inch, CMOS
<b>Effective Pixels</b>	8.46M	8.42M
<b>Focal Length</b>	f=3.47mm~41.65mm	f=6.7mm ~ 125mm
<b>Output Resolutions</b>	HDMI & SDI 3840x2160p60/59.94/50/30/29.97/25   1080p60/59.94/50/30/29.97/25   1080i60/59.94/50   720p60/59.94/50	
	Network (H.265 / H.264 / MJPEG) 3840x2160 (MJPEG excluded), 1920x1080, 1280x720 etc. (First Stream: 32kbps~84000kbps; Second Stream: 32kbps~20480kbps)	
<b>Aperture</b>	F1.84~F3.72	F1.58 ~ F3.95
<b>Horizontal View Angle</b>	80.8° ~ 7.5°	60° ~ 3.5°
<b>Vertical View Angle</b>	50° ~ 4.3°	35.7° ~ 2.0°
<b>Horizontal Rotation Range</b>	±170°	
<b>Vertical Rotation Range</b>	-90° ~ +210°	
<b>Pan Speed Range</b>	1.8°/s ~ 78°/s (test average)	
<b>Tilt Speed Range</b>	1.5°/s ~ 50°/s (test average)	
<b>Scanning Mode</b>	Progressive	
<b>Digital Zoom</b>	16X	
<b>Scanning Method</b>	Progressive	
<b>Minimum Illumination</b>	0.5 Lux @ (F1.8, AGC ON)	
<b>Digital Noise Reduction</b>	3D Digital Noise Reduction	
<b>White Balance</b>	Auto / Manual/ One Push/ Indoors/ Outdoors/VAR	
<b>Focus</b>	Auto / Manual	
<b>Iris</b>	Auto / Manual	
<b>Shutter</b>	Auto / Manual	
<b>Backlight Compensation</b>	ON/OFF	
<b>Dynamic Range</b>	OFF/ Dynamic Level Adjustment	
<b>Video Adjustment</b>	Brightness/Hue/Saturation/Contrast/Sharpness/B/W Mode/Gamma Curve	
<b>Signal Noise Ratio</b>	40dB(H.264)	
<b>Image Flip</b>	Auto / Manual	
<b>Image Freeze</b>	Support	
<b>PoE+</b>	Support	
<b>Number of Preset</b>	255	
<b>Preset Accuracy</b>	0.1°	



USB Features	
Operate System	Windows 7/8/10, Mac OS X, Linux, Android
Color System/ Compression	<ul style="list-style-type: none"> <li>●3.0 (Optional): YUY2/H.264/H.265/MJPEG</li> <li>●USB Type-C: H.264/H.265/MJPEG</li> </ul>
Video Format	<ul style="list-style-type: none"> <li>●YUY2: (USB 3.0 support)max to 1080P@30fps, USB 3.0/Type-C support</li> <li>●H.264 AVC: max to 2160P@30fps</li> <li>●H.265 HEVC: max to 2160P@30fps</li> <li>●MJPEG: max to 2160P@30fps</li> </ul>
USB Audio	Support
USB Video Protocol	UVC 1.1 ~ 1.5
UVC PTZ	Support
Network Features	
Video Compression	H.264/H.265/MJPEG
Video Stream	First Stream, Second Stream
First Stream Resolution	3840x2160, 1920x1080, 1280x720, 1024x576, 720x480, 720x408, 640x480, 640x360
Second Stream Resolution	720x480, 720x408, 640x480, 640x360, 480x320, 320x240
Bit Rate Control	CBR, VBR
Frame Rate	50Hz: 1fps ~ 50fps 60Hz: 1fps ~ 60fps
Audio Compression	AAC   G.711A
Audio Bit Rate	96Kbps, 128Kbps
Protocols	NDI®   HX2 (*NDI model supported only), RTSP, RTMP, ONVIF, Pelco-D, Pelco-P, VISCA, FreeD
Input/Output Interface	
HDMI Interface	1 x HDMI: Version 2.0
12G-SDI Interface	1 x 12G-SDI: BNC type, 800mVp-p, 75Ω. Along to ST2082-1   ST2081-1   ST424   ST292-1 standard
LINE IN Interface	1 x LINE IN: 3.5mm Audio Interface
Communication Interface	1 x RS485/RS422: 4pin phoenix port (RS485-2PIN   RS422-4PIN), Max Distance: 1200m, Protocol: VISCA/Pelco-D/Pelco-P
	1 x RS232 IN: 8-pin Min DIN, Max Distance: 30m, Protocol: VISCA/Pelco-D/Pelco-P
	1 x RS232 OUT: 8-pin Min DIN, Max Distance: 30m, Protocol: VISCA network use
USB Interface	1 x USB: Type-C
LAN(PoE+) Interface	1 x LAN: 1000M Adaptive Ethernet Port, support PoE+
Power Jack	JEITA type (DC IN 12V)
Physical Parameter	
Tally Indicator	1
Power Indicator	1
Status Indicator	1
Restore Key	1
Power Switch	1
Input Voltage	DC 12V/PoE+(802.3at)
Input Current	Max. 2A
Operating Temperature	0°C ~ 40°C
Storage Temperature	-40°C ~ 60°C
Power Consumption	Max. 18W
Net Dimension	212mm x 176mm x 232mm
Net Weight	12X: 2.27 Kg
	20X: 2.14 Kg
Packaged Weight	12X: 3.21 Kg
	20X: 3.06 Kg

# Chapter 2 Install Your Product

## 2.1 Interface and Switch

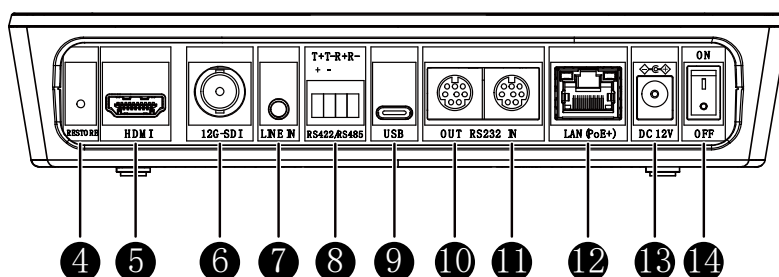
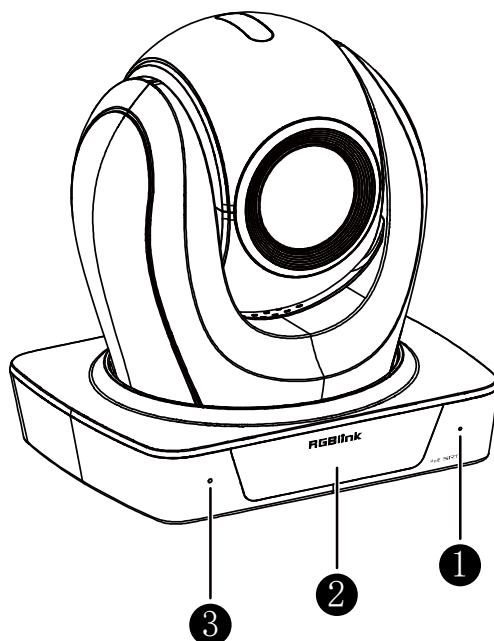

Item	Name
1	Built-in Microphone
2	Display Screen
3	Built-in Microphone
4	RESTORE Key
5	HDMI Interface
6	12G-SDI Interface
7	LINE IN Interface
8	RS422/RS485 Interface
9	USB Interface
10	RS232 OUT Interface
11	RS232 IN Interface
12	LAN(PoE+) Interface
13	DC 12V Interface
14	Power Switch

## 2.2 RS232 Interface

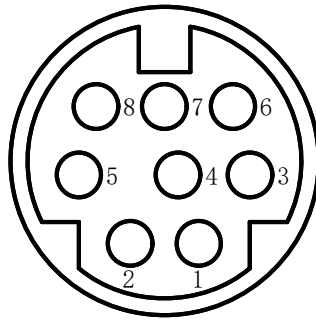

No.	Function	No.	Function
1	DTR	5	RXD
2	DSR	6	GND
3	TXD	7	IR OUT
4	GND	8	NC

Correspondence between RS232 and DB-9:

RS232	DB-9
1.DTR	1.CD
2.DSR	2.RXD
3.TXD	3.TXD
4.GND	4.DTR
5.RXD	5.GND
6.GND	6.DSR
7.IR OUT	7.RTS
8.NC	8.CTS
-	9.RI

Correspondence between RS232 and Mini DIN:

RS232	Mini DIN
1.DTR	1.DTR
2.DSR	2.DSR
3.TXD	3.TXD
4.GND	4.GND
5.RXD	5.RXD
6.GND	6.GND
7.IR OUT	7.NC
8.NC	8.NC

## 2.3 Quick Start

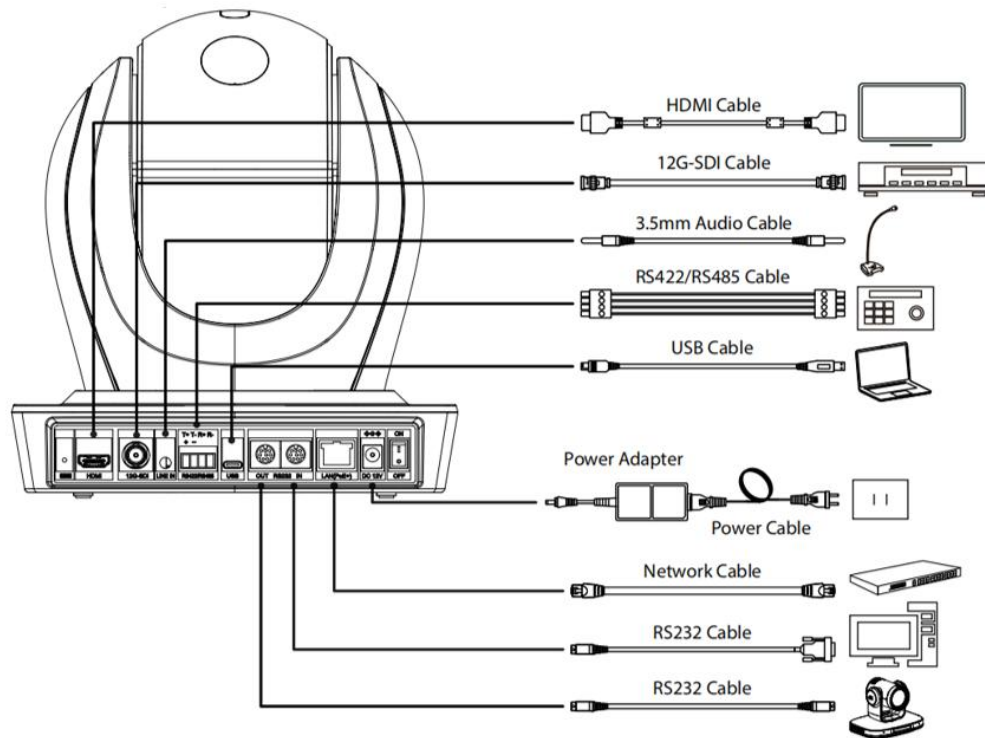

- 1) Please check connections are correct before starting.
- 2) Connect the power adapter to the power connector on the rear panel of the camera. The power indicator on the front panel of the camera is on.
- 3) After the camera is powered on, it starts to initialize, right up to the limit position, and then both horizontal and vertical go to the middle position, the motor stops running, and the initialization is completed.  
(Note: If preset 0 is saved, PTZ will be move to preset 0)

## 2.4 Installation

### 2.4.1 Wall Mount

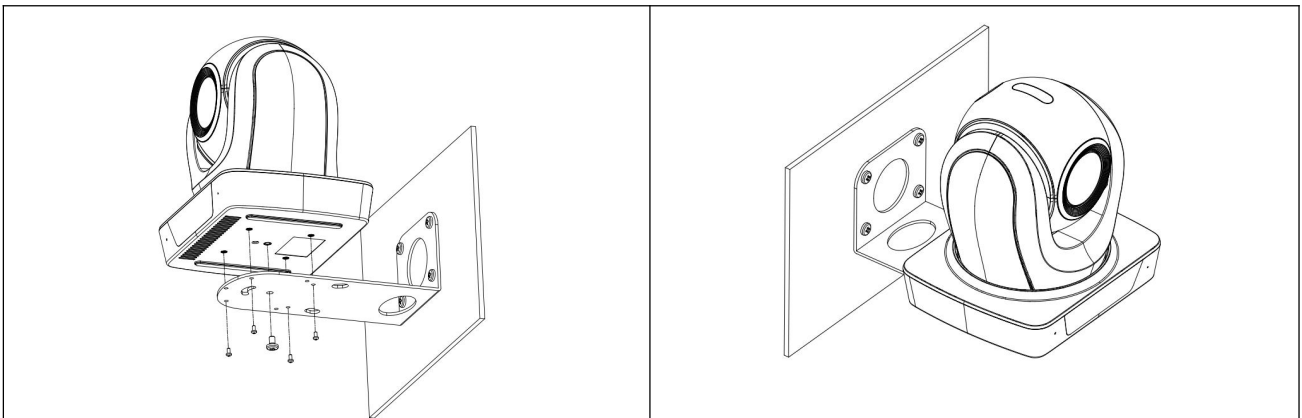

## 2.4.2 Ceiling Mount

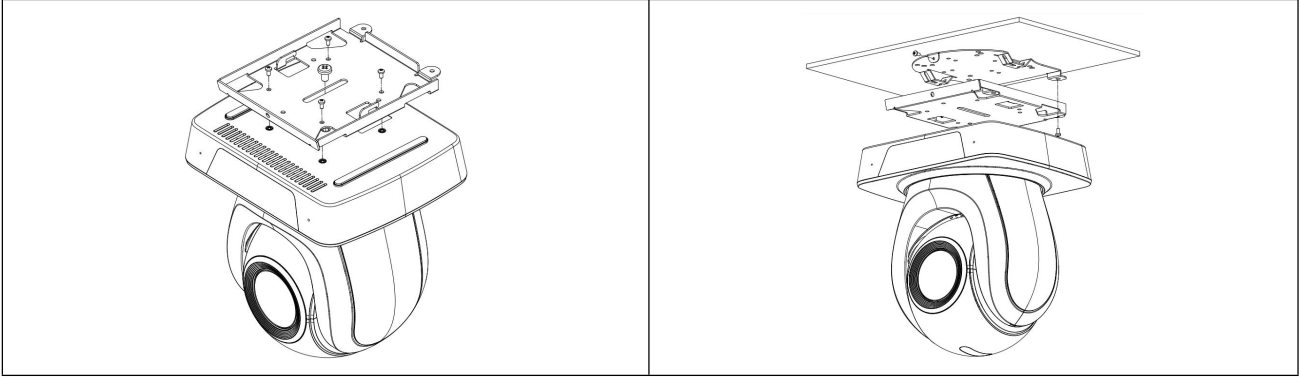

**Note:** The installation diagram is for reference only. The brackets and screws are not standard. For packing accessories, please refer to the actual product.

---

# Chapter 3 Use Your Product

---

## 3.1 Remote Controller

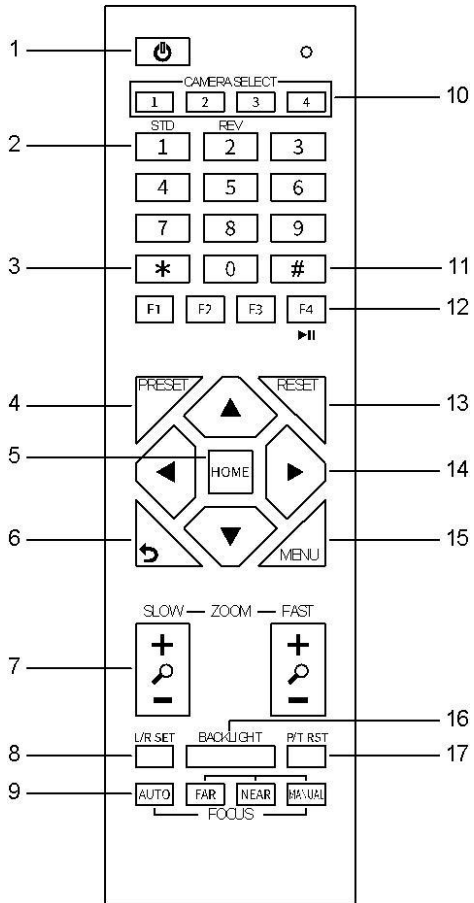

### 1. Standby Key

Press to enter standby mode

### 2. Number Key

Press to set preset or call preset.

### 3. \*Key

Use with other keys

### 4. PRESET Key

Set preset: [PRESET] + Number key (0-9)

### 5. Home Key

Confirm selection or press to turn PTZ back to the middle position

### 6. Return Key

Press to return to the previous menu

### 7. Zoom Key

- SLOW: Zoom In [+] or Zoom Out [-] slowly
  - FAST: Zoom In [+] or Zoom Out [-] fast
- Press Key: Right

### 8. L/R SET Key

- Standard: Simultaneously press L/R SET + 1
- Reverse: Simultaneously press L/R SET + 2

### 9. FOCUS Key

Auto/Manual/Far/Near focus

### 10. CAMERA SELECT Key

Press to select and control the camera

### 11. #Key

Use with other keys

### 12. IR Remote Control Key

[\*]+[#]+[F1]: Address 1

[\*]+[#]+[F2]: Address 2

[\*]+[#]+[F3]: Address 3

[\*]+[#]+[F4]: Address 4

### 13. RESET Key

Clear preset position: [RESET] + Number key (0-9)

---

## 14. PTZ Control Key

PTZ moved according to the arrow indicates

## 15. MENU Key

Press to enter or exit OSD Menu

## 16. BACKLIGHT Key

Backlight ON/OFF: Press repeatedly to enable or disable the backlight compensation.

NOTE:

- Effective only in auto exposure mode.
- If there is a light behind the subject, the subject will become dark, press the backlight key to enable the backlight compensation. Press again to disable this function.

## 17. P/T RST (PTZ Reset) Key

PTZ starts to self-test after pressed it

## 18. Shortcut Key

[\*]+[#]+[1]: OSD menu default English

[\*]+[#]+[3]: OSD menu default Chinese

[\*]+[#]+[4]: Display current IP address

[\*]+[#]+[6]: Quickly recover the default

[\*]+[#]+[8]: View the camera version

[\*]+[#]+[9]: Quickly set up inversion

[\*]+[#]+[MANUAL]: Restore default IP address

# 3.2 GUI Settings

## 3.2.1 MENU

Press [MENU] key to display the main menu on the normal screen, using arrow key to move the cursor to the item to be set. Press the [HOME] key to enter the corresponding sub-menu.

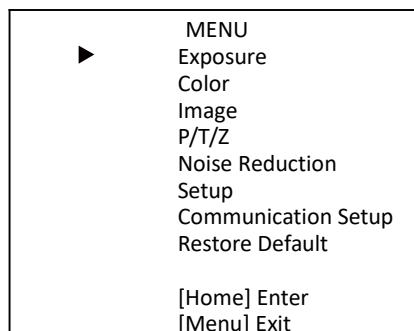

## 3.2.2 EXPOSURE

Move the main menu cursor to [Exposure], and press [HOME] key enter the exposure page, as shown in the following figure.

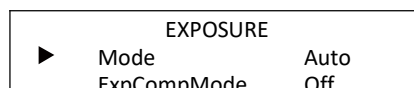

EXPOSURE	
Backlight	Off
Gain Limit	10
Anti-Flicker	50Hz
Meter	Average
DRC	1
▲▼Select Item	
◀▶Change Value	
[Menu] Back	

**Mode:** Auto, Manual, SAE, AAE, Bright.

**ExpCompMode:** On, Off (Effective only in Auto mode).

**ExpComp:** -7 ~ 7 (Effective only in ExpCompMode item to On).

**Backlight:** On, Off (Effective only in Auto mode).

**Bright:** 0 ~ 17 (Effective only in Bright mode).

**Gain Limit:** 0 ~ 15 (Effective only in Auto, SAE, AAE, Bright mode).

**Anti-Flicker:** Off, 50Hz, 60Hz (Effective only in Auto, AAE, Bright mode).

**Meter:** Average, Center, Smart, Top.

**Iris:** F1.8, F2.0, F2.4, F2.8, F3.4, F4.0, F4.8, F5.6, F6.8, F8.0, F9.6, F11.0, Close (Effective only in Manual, AAE mode).

**Shutter:** 1/30, 1/60, 1/90, 1/100, 1/125, 1/180, 1/250, 1/350, 1/500, 1/725, 1/1000, 1/1500, 1/2000, 1/3000, 1/4000, 1/6000, 1/10000 (Effective only in Manual, SAE mode).

**Gain:** 0 ~ 7 (Effective only in Manual mode).

**DRC:** 0 ~ 8.

### 3.2.3 COLOR

Move the main menu cursor to [Color], and press [HOME] key enter the color page, as shown in the following figure.

COLOR	
▶ WB Mode	Auto
RG Tuning	0
BG Tuning	0
Saturation	100%
Hue	7
▲▼Select Item	
◀▶Change Value	
[Menu] Back	

**WB Mode:** Auto, Indoor, Outdoor, One Push, Manual, VAR.

**RG:** 0 ~ 255 (Effective only in Manual mode).

**BG:** 0 ~ 255 (Effective only in Manual mode).

**RG Tuning:** -10 ~ +10 (Effective only in Auto, One Push, VAR Mode).

**BG Tuning:** -10 ~ +10 (Effective only in Auto, One Push, VAR Mode).

**Saturation:** 60% ~ 200%.

**Hue:** 0 ~ 14.

**Color Temp:** 2500K ~ 8000K (Effective only in VAR mode).

### 3.2.4 IMAGE

Move the main menu cursor to [Image], and press [HOME] key enter the image page, as shown in the following figure.

IMAGE	
▶ Luminance	6
Contrast	9
Sharpness	3
Flip-H	Off
Flip-V	Off
B&W-Mode	Off
Style	Default



IMAGE  
 ▲▼Select Item  
 ◀▶Change Value  
 [Menu] Back

**Luminance:** 0 ~ 14.  
**Contrast:** 0 ~ 14.  
**Sharpness:** 0 ~ 15, auto.  
**Flip-H:** On, Off.  
**Flip-V:** On, Off.  
**B&W-Mode:** On, Off.  
**Style:** Default, Norm, Bright, PC.

### 3.2.5 P/T/Z

Move the main menu cursor to [P/T/Z], and press [HOME] key enter the P/T/Z page, as shown in the following figure

P/T/Z  
 ▶ SpeedByZoom On  
 AF-Zone Front  
 AF-Sense High  
 L/R Set STD  
 Display Info On  
 Image Freeze Off  
 Digital Zoom Off  
 Call Preset Speed 24  
 Pre Zoom Speed 5  
 ▲▼Select Item  
 ◀▶Change Value  
 [Menu] Back

**SpeedByZoom:** On, Off.  
**AF-Zone:** Front, Top, Center, Bottom.  
**AF-Sense:** Low, Normal, High.  
**L/R Set:** STD, REV.  
**Display Info:** On, Off.  
**Image Freeze:** On, Off.  
**Digital Zoom:** Off, 2x, 4x, 8x, 16x.  
**Call Preset Speed:** 1 ~ 24.  
**Pre Zoom Speed:** 0 ~ 7.

### 3.2.6 NOISE REDUCTION

Move the main menu cursor to [Noise Reduction], and press [HOME] key enter the noise reduction page, as shown in the following figure.

NOISE REDUCTION  
 ▶ NR3D-Level 6  
 ▲▼Select Item  
 ◀▶Change Value  
 [Menu] Back

**NR3D Level:** Off, 1 ~ 9.

### 3.2.7 SETUP

Move the main menu cursor to [Setup], and press [HOME] key enter the setup page, as shown in the following figure.

SETUP  
 ▶ Language EN  
 DVI Mode HDMI  
 Video Format 1080P30  
 Auto Scan Shoot Off

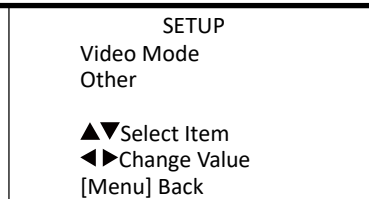

**Language:** EN, Chinese, Russian.

**DVI Mode:** HDMI, DVI.

**Video Format:** 4KP25, 4KP29.97, 4KP30, 4KP50, 4KP59.94, 4KP60, 1080P30, 1080P25, 1080P50, 1080P60, 1080P59.94, 1080P29.97, 1080I50, 1080I60, 1080I59.94, 720P60, 720P59.94, 720P50.

**Auto Scan Shoot:** On, Off.

**Video Mode:** SDI-12G Mode, Video Output.

**SDI-12G Mode:** LEVEL-A, LEVEL-B.

**Video Output:** HDMI, SDI.

**Other:** Auto Inversion, Tally Mode, USB Type-C Audio.

**Auto Inversion:** On, Off.

**Tally Mode:** On, Off.

**USB Type-C Audio:** On, Off (Only for USB Type-C).

### 3.2.8 COMMUNICATION SETUP

Move the main menu cursor to [Communication Setup], and press [HOME] key enter the communication setup page, as shown in the following figure.

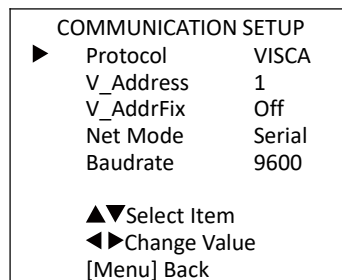

**Protocol:** Auto, VISCA, PELCO-D, PELCO-P.

**V\_Address:** 1 ~ 7 (Effective only in Auto, VISCA protocol).

**V\_AddrFix:** On, Off (When set to On, useless in 88 30 01 FF Command).

**P\_D\_Address:** 0 ~ 254 (Effective only in Auto, PELCO-D protocol).

**P\_P\_Address:** 0 ~ 31 (Effective only in Auto, PELCO-P protocol).

**Net Mode:** Serial, Paral.

**Baudrate:** 2400, 4800, 9600, 38400.

### 3.2.9 RESTORE DEFAULT

Move the main menu cursor to [Restore Default], press [HOME] key enter restore default page, as shown in the following figure.

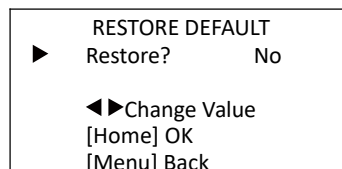

**Restore:** Yes, No.

**Note:** GUI menu and parameters are subject to change without notice.

## 3.3 WEB Settings

### 3.3.1 Access Camera

Access <http://192.168.100.88> to pop up the login window, then input username (default: admin) and password (default: admin). After login, it will show as below:



### 3.3.2 Control Camera

All pages include two menu bars:

Real time monitoring: displaying video image  
Parameter setup: with function buttons.

#### A. Video Viewing Window

Video viewing window must be same as video resolution, the bigger the resolution is, the bigger the playing area is. Double click viewing window, will show full-screen, double click again, will return to initialized size.

Status bar in viewing window shown as below:



- 1) Video playback pause button: control real-time video pause, stop the last picture, click recoverable video again.
- 2) Audio control buttons: can adjust the volume or set silent mode.
- 3) Full screen switch button.

#### B. PTZ Setup

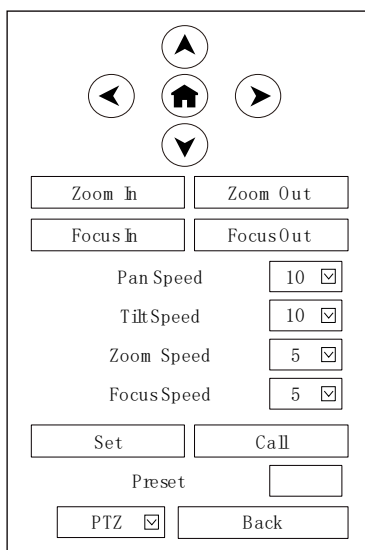

### 1) Pan and Tilt Control

Up, Down, Left and Right arrows and the home button allow you to manually drive the camera to the desired position.

### 2) Zoom

Zoom In and Zoom Out buttons allow for wide or narrow view of the space.

### 3) Focus

Focus In and Focus Out buttons allow for fine manual focus adjustment if the camera has any problems auto focusing on the difficult object.

### 4) PTZ Speeds

Pan speed can be set at any rate between 1 ~ 24, Tilt speed can be set at any rate between 1 ~ 20. Zoom and Focus speeds can be set at any rate between 1 ~ 7.

### 5) PTZ Presets

After manually setting up a shot that you would like to return to later, you can save presets for quick recall of these positions. Type a number between 0 and 254 into the Preset box.

Click the "Set" button to save the current location with that preset number. Click the "Call" button to cause the camera to return to that position. This enables smooth, quick and convenient control without the need to manually drive the camera.

You can set up preset that user want as below.

Method: Type preset number into the Preset box.

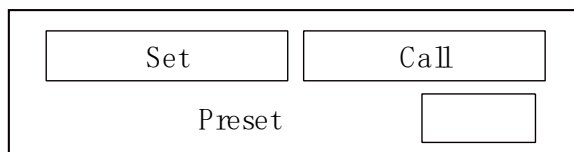

Preset: Optional items: 0 ~ 254.

### 6) PTZ/OSD Dropdown

From the dropdown menu, clicking the OSD option will open the on-screen display menu of the camera giving you control from within the IP interface.

## C. Language Selection

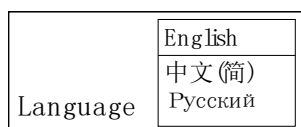

Click either "Chinese", "English" or "Russian" to change the language of the webpage.

### 3.3.3 Video Settings

Video Settings

HDMI/SDI Output

Video Format

Encode Level

First stream

Encode Protocol

Resolution

Bit Rate

Frame Rate   fps

IKey Frame Interval

Bit Rate Control

Second stream

Encode Protocol

Resolution

Bit Rate

Frame Rate   fps

IKey Frame Interval

Bit Rate Control

#### 1) HDMI/SDI Output

Support HDMI and SDI Output.

#### 2) Video Format

HDMI output support 3840x2160/60p, 3840x2160/59.94p, 3840x2160/50p, 3840x2160/30p, 3840x2160/29.97p, 3840x2160/25p. Both HDMI and SDI output support 1920x1080/60p, 1920x1080/59.94p, 1920x1080/50p, 1920x1080/60i, 1920x1080/59.94i, 1920x1080/50i, 1920x1080/30p, 1920x1080/29.97p, 1920x1080/25p, 1280x720/60p, 1280x720/59.94p, 1280x720/50p.

#### 3) Encode Level

Support mainprofile and highprofile two levels.

#### 4) Encode Protocol

Support H.264, H.265 and MJPEG protocols.

#### 5) Resolution

First stream support 3840x2160, 1920x1080, 1280x720, 1024x576, 720x480, 720x408, 640x480, 640x360. Second stream support 720x480, 720x408, 640x480, 640x360, 480x320, 320x240; The bigger resolution is, the clearer the image will be, more network bandwidth will be taken.

#### 6) Bit Rate

The user can specify the bit rate. Generally speaking, the larger of the bit rate, the clearer of the image. However, the configuration of the bit rate needs to be combined with the network bandwidth. When the network bandwidth is narrow and the bit rate is configured larger, the video stream cannot be transmitted normally, and the visual effect is worse.

### 7) Frame Rate

User can specify the size of the frame rate, generally, the frame rate greater, the image more smooth; Frame rate is smaller, the more sense of beating.

### 8) I Key Frame Interval

Set interval between 2 I frame, the bigger interval is the response will be lower from view window.  
Bit Rate Control.

### 9) Code stream control way:

CBR (Constant Bit Rate): Video coder will be coding according to preset speed.

VBR (Variable Bit Rate): Video coder will adjust the speed based on preset speed to gain the best image quality.

## 3.3.4 Image Settings

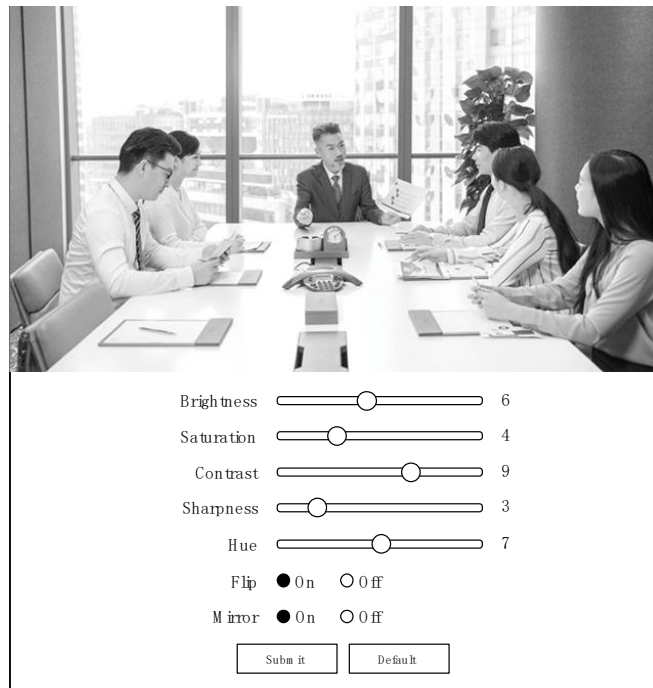

#### 1) Brightness

Brightness of image: 0~14 (Default value is 6).

#### 2) Saturation

Saturation of image: 0~14 (Default value is 4).

#### 3) Contrast

Contrast of image: 0~14 (Default value is 9).

#### 4) Sharpness

Sharpness of image: 0~16 (Default value is 3).

#### 5) Hue

Hue of image: 0~14 (Default value is 7).

#### 6) Flip

Turn On/Off the Flip function.

#### 7) Mirror

Turn On/Off the Mirror function.

### 3.3.5 Audio Settings

Audio Settings

Audio Switch

Audio Type

Sample Rate

Bit Rate

Input Type

Input Vol  dB

ADTS Options

**1) Audio Switch**

Enable or disable audio switch.

**2) Audio Type**

Optional items: AAC.

**3) Sample Rate**

Optional items: 44.1K, 48K.

**4) Bit Rate**

Optional items: 96K, 128K.

**5) Input Type**

Optional items: LINE IN, MIC.

**6) Input Vol**

The volume of the channel.

**7) ADTS Options**

Optional items: On, Off.

### 3.3.6 System Settings

Initialize

Reboot

User

User Name

Password

Guest

Password

**1) Reboot**

Click the “Reboot” button, system restart.

## 2) Username and Password

The user can modify the password (letters and Numbers only).

### 3.3.7 Network Settings

#### Lan Settings

IP Configuration Type  Fixed IP Address

IP Address

Subnet Mask

Gateway

DNS Address

MAC Address

#### Port Settings

HTTP Port

RTSP Port

TCP Port

UDP Port

Sony Visca

#### RTSP Settings

First Stream  On  Off  Video  Audio

MRL

Second Stream  On  Off  Video  Audio

MRL

#### SRT Settings

SRT  On  Off

SRT Port

SRT Encryption  None

SRT Password

#### RTSP Settings

RTSP Auth  On  Off

#### ONVIF Settings

ONVIF  On  Off

ONVIF Auth  On  Off

#### Multicast Settings

Multicast  On  Off

Address

Port

#### NTP Settings

NTP time sync  On  Off

Time Zone  GMT+08:00 Beijing, China

Server address

Time interval (min)

Main time show  On  Off

Position

Sub time show  On  Off

Position

#### 1) Lan Settings

Default the IP address is 192.168.100.88, the MAC address cannot be modified.

#### 2) Port Settings

##### A. HTTP Port

IP address identifies the network device, the device can run multiple web applications, each network program



---

using network port to transmit data, so data transmission to be carried out between the port and port. Port setting is to set up web server program using which port to transmit. When port mapping, need to be consistent with the port number (default port: 80).

**B. RTSP Port**

The 4K PTZ camera support RTSP protocol, use the VLC tools broadcast, default port: 554.

**C. TCP Port**

Support TCP connection then control camera, default port: 5678.

**D. UDP Port**

Support UDP protocol, default port: 1259.

**E. Sony Visca**

Support Sony Visca, default value: 52381.

**3) RTMP(S) Settings**

Setting the MRL of RTMP, select enable or disable video and audio. You can select control code stream of "On", "Off", "Video", "Audio" between in the two streams.

**4) SRT Settings**

Turn On/Off SRT, Setting the SRT Port, SRT Encry and SRT Password.

**5) RTSP Settings**

Turn On/Off RTSP Auth.

**6) ONVIF Settings**

Turn On/Off ONVIF and ONVIF Auth.

**7) Multicast Settings**

Turn On/Off multicast. Setting the multicast address (default value is 224.1.2.3) and port (default value is 6688, then 6688 is the multicast port of the first stream; 6690 is the multicast port of the second stream).

**8) NTP Settings**

Turn On/Off NTP time sync, main time show and sub time show. Setting NTP server address, time interval, main stream position and sub stream position.

### 3.3.8 System Settings

Information	
Device ID	UHD Camera
Device Type	G68.RG
Software Version	SOC V2.0.01 - ARM 6.1.42SRG
Webware Version	v1.5.6
<input type="button" value="Submit"/> <input type="button" value="Cancel"/>	

### 3.3.9 Download Upgrade Program

If you need the camera upgrade program, please contact the manufacturer.

**Note:** WEB interface and parameters are subject to change without notice.

---

## Chapter 4 Ordering Codes

---

### 4.1 Product Code

Product Code	Model
981-0011-66-0	RGB12X-UPAI-OL, 12X RGBlink 4K vue PTZ camera
981-0011-67-0	RGB12X-UNAI-OL, 12X RGBlink 4K vue NDI PTZ camera
981-0011-78-0	RGB20X-UPAI-OL, 20X RGBlink 4K vue PTZ camera
981-0011-79-0	RGB20X-UNAI-OL, 20X RGBlink 4K vue NDI PTZ camera

---

# Chapter 5 Support

---

## 5.1 Contact Us

[www.rgblink.com](http://www.rgblink.com)



### Inquiries

+86-592-577-1197  
info@rgblink.com  
rgblink.com/contact-us

### Global Support

support@rgblink.com  
rgblink.com/support-me



@RGLINK



/rgblink



+rgblink



/rgblink



rgblink



rgblink

### RGBlink Headquarters

Room 601A, No. 37-3  
Banshang community,  
Building 3, Xinke Plaza, Torch  
Hi-Tech Industrial  
Development Zone, Xiamen,  
China

+86-592-577-1197

### China Regional Sales & Support

705, 7th Floor, South District,  
Building 2B, Skyworth  
Innovation Valley, No. 1  
Tangtou Road, Shiyuan Street,  
Baoan District, Shenzhen City,  
Guangdong Province

+86-755 2153 5149

### Beijing Region Office

Beijing, China  
Building 8, 25 Qixiao Road  
Shahe Town Changping

+010- 8577 7286

### Europe Regional Sales & Support

Eindhoven, Holland  
Flight Forum Eindhoven  
5657 DW

+31 (040) 202 71 83

---

## 5.2 Troubleshooting

### Image

- The monitor shows no image

- 1) Check that the camera power supply is connected, the voltage is normal, and the power indicator light is always on.
- 2) Turn off the power switch to check whether the camera is self-testing.
- 3) Check the cable of video platform and TV whether correct connection.

- The video image displayed by the camera lens is jittery

- 1) Check whether the camera installed position be stabled.
- 2) Check whether have vibrating machinery or object near the camera.

- There is no video image in Browser

IE browser does not support H5, you need to use VLC plug-in to view videos. Please access VLC website (<http://www.videolan.org/vlc>) download and install the 32-bit VLC media player, after it installed, access 4K PTZ camera will have normal image display. Other mainstream browsers already support H5 and do not need to install the VLC plug-in.

- Unable to access 4K PTZ camera through Browser

- 1) Using PC to access the network to test whether the network access can work properly, first of all, the network fault caused by the PC virus can be eliminated, until the PC and 4K PTZ camera can communicate with each other Ping.
- 2) Disconnect the network, connect 4K PTZ camera and PC separately, and reset the IP address of PC.
- 3) Check IP address, subnet mask, and gateway settings for 4K PTZ camera.
- 4) Check whether the MAC address is conflicts.
- 5) Check whether the web port is modified.
- 6) The default web port is 80.

- Forget the IP address or login password

Please remember (The default IP address: 192.168.100.88; default user name: admin; default password: admin).

### Control

- Remote control cannot control

- 1) Check and replace the new battery for the remote controller.
- 2) Check whether the camera working mode is correct.
- 3) Check whether the address of remote control can match the camera.

- Serial port cannot control

- 1) Check whether the camera protocol, address and baud rate such is the same.
- 2) Check whether the control line is connected well.

---

# Chapter 6 Appendix

---

## 6.1 VISCA Protocol List

Function	Command
Query menu language (00 English 01 Chinese 02 Russian)	81 09 11 53 FF
Modify default language English	81 0A 11 58 00 FF
Chinese	81 0A 11 58 01 FF
Russian	81 0A 11 58 02 FF
Query Power	81 09 04 00 FF
Query Zoom Position	81 09 04 47 FF
Query Focus Mode	81 09 04 38 FF
Query Focus Position	81 09 04 48 FF
Query White Balance Mode	81 09 04 35 FF
Query Red Gain	81 09 04 43 FF
Query Blue Gain	81 09 04 44 FF
Query Exposure Mode	81 09 04 39 FF
Query Shutter Position	81 09 04 4A FF
Query Iris Position	81 09 04 4B FF
Query Gain	81 09 04 4C FF
Query Brightness	81 09 04 4D FF
Query Exposure Compensation Mode	81 09 04 3E FF
Query Exposure Compensation Position	81 09 04 4E FF
Query Noise 3D Level	81 09 04 54 FF
Query Flicker Level	81 09 04 55 FF
Query Aperture Level	81 09 04 42 FF
Query ApertureModelInq	81 09 04 05 FF
Query Menu Status	81 09 06 06 FF
Picture Effect ModelInq	81 09 04 63 FF
MeteringModelInq	81 09 04 3A FF
GainLimitInq	81 09 04 2C FF
AFSensitivityInq	81 09 04 58 FF
BrightnessInq	81 09 04 A1 FF
ContrastInq	81 09 04 A2 FF
FlipInq	81 09 04 A4 FF
GammatInq	81 09 04 5B FF
DVIModelInq	81 09 04 AB FF
ColorHueInq	81 09 04 4F FF
AWBSensitivityInq	81 09 04 A9 FF
Query ColorGainInq	81 09 04 49 FF
Query Flip Horizontal	81 09 04 61 FF
Query Flip Vertical	81 09 04 66 FF

Query IR Receive	81 09 06 08 FF
Query Motor Max Speed	81 09 06 11 FF
Query Motor Position	81 09 06 12 FF
Address Set	88 30 01 FF
Zoom In	81 01 04 07 02 FF
Zoom Out	81 01 04 07 03 FF
Zoom In (Fast)	81 01 04 07 27 FF
Zoom Out (Fast)	81 01 04 07 37 FF
Zoom Stop	81 01 04 07 00 FF
Zoom In To Limit	81 01 04 47 04 00 00 00 FF
Zoom Out To Limit	81 01 04 47 00 00 00 00 FF
Focus Manual	81 01 04 38 03 FF
Focus Far	81 01 04 08 02 FF
Focus Near	81 01 04 08 03 FF
Focus Auto	81 01 04 38 02 FF
Focus Manual	81 01 04 38 03 FF
Focus Far (Fast)	81 01 04 08 27 FF
Focus Near (Fast)	81 01 04 08 37 FF
Focus Stop	81 01 04 08 00 FF
One-key focus	81 01 04 38 04 FF
Focus Manual	81 01 04 38 03 FF
Focus Far To Limit	81 01 04 48 01 04 03 00 FF
Focus Near To Limit	81 01 04 48 01 04 00 00 FF
AUTO/MANUAL	81 01 04 38 10 FF
One Push Triger	81 01 04 18 01 FF
White Balance Auto	81 01 04 35 00 FF
White Balance Indoor	81 01 04 35 01 FF
White Balance Outdoor	81 01 04 35 02 FF
White Balance OnePush	81 01 04 35 03 FF
OnePush trigger	81 01 04 10 05 FF
White Balance Manual	81 01 04 35 05 FF
White Balance Temperature	81 01 04 35 20 FF
Specified color temperature up	81 01 04 20 02 FF
down	81 01 04 20 03 FF
reset	81 01 04 20 00 FF
Specified color temperature DIRECT	81 01 04 20 00 09 FF
White Balance Auto	81 01 04 35 00 FF
White Balance Manual	81 01 04 35 05 FF
Red Gain To Min	81 01 04 43 00 00 00 00 FF
Red Gain Up	81 01 04 03 02 FF
Red Gain Down	81 01 04 03 03 FF
Red Gain To Max	81 01 04 43 00 00 0F 0F FF
Red Gain Reset	81 01 04 03 00 FF
Blue Gain To Min	81 01 04 44 00 00 00 00 FF

Blue Gain Up	81 01 04 04 02 FF
Blue Gain Down	81 01 04 04 03 FF
Blue Gain To Max	81 01 04 44 00 00 0F 0F FF
Blue Gain Reset	81 01 04 04 00 FF
Exposure Mode Auto	81 01 04 39 00 FF
Exposure Mode Manual	81 01 04 39 03 FF
Exposure Mode Shutter Priority	81 01 04 39 0A FF
Exposure Mode Iris Priority	81 01 04 39 0B FF
Exposure Mode Bright	81 01 04 39 0D FF
MeteringMode	81 01 04 3A 00 FF
center	81 01 04 3A 01 FF
smart	81 01 04 3A 02 FF
Top	81 01 04 3A 03 FF
Exposure Mode Manual	81 01 04 39 03 FF
Shutter Reset	81 01 04 0A 00 FF
Shutter Up	81 01 04 0A 02 FF
Shutter Down	81 01 04 0A 03 FF
Shutter To Middle	81 01 04 4A 00 00 00 08 FF
Shutter To Middle	81 01 04 4A 00 00 00 0C FF
Shutter To Middle	81 01 04 4A 00 00 01 01 FF
Shutter To Fastest	81 01 04 4A 00 00 01 05 FF
gain reset	81 01 04 0C 00 FF
up	81 01 04 0C 02 FF
down	81 01 04 0C 03 FF
direct	81 01 04 0C 00 00 00 06 FF
Exposure Mode Auto	81 01 04 39 00 FF
Gain Limit direct (pq 0-15)	81 01 04 2c 01 FF
Exposure Mode Bright	81 01 04 39 0D FF
bright reset	81 01 04 0D 00 FF
up	81 01 04 0D 02 FF
down	81 01 04 0D 03 FF
direct	81 01 04 0D 00 00 00 0d FF
Aperture priority	81 01 04 39 0B FF
Iris Reset	81 01 04 0B 00 FF
Iris Up	81 01 04 0B 02 FF
Iris Down	81 01 04 0B 03 FF
Iris Close	81 01 04 4B 00 00 00 00 FF
f11.0	81 01 04 4B 00 00 00 01 FF
f9.6	81 01 04 4B 00 00 00 02 FF
f8.0	81 01 04 4B 00 00 00 03 FF
f6.8	81 01 04 4B 00 00 00 04 FF
f5.6	81 01 04 4B 00 00 00 05 FF
f4.8	81 01 04 4B 00 00 00 06 FF
f4.0	81 01 04 4B 00 00 00 07 FF

f3.4	81 01 04 4B 00 00 00 08 FF
f2.8	81 01 04 4B 00 00 00 09 FF
f2.4	81 01 04 4B 00 00 00 0A FF
f2.0	81 01 04 4B 00 00 00 0B FF
f1.8	81 01 04 4B 00 00 00 0C FF
Exposure Mode Auto	81 01 04 39 00 FF
Exposure Compensation On	81 01 04 3E 02 FF
Exposure Compensation Reset	81 01 04 0E 00 FF
Exposure Compensation Up	81 01 04 0E 02 FF
Exposure Compensation Down	81 01 04 0E 03 FF
Exposure Compensation To Min	81 01 04 4E 00 00 00 00 FF
Exposure Compensation To Max	81 01 04 4E 00 00 00 0E FF
Exposure Compensation off	81 01 04 3E 03 FF
Backlight On	81 01 04 33 02 FF
Backlight off	81 01 04 33 03 FF
DIRECT 0	81 01 04 25 00 00 00 00 FF
DIRECT 7	81 01 04 25 00 00 00 07 FF
Noise Reduction 2D Close	81 01 04 53 00 FF
Noise Reduction 2D Low	81 01 04 53 01 FF
Noise Reduction 2D Middle	81 01 04 53 03 FF
Noise Reduction 2D High	81 01 04 53 05 FF
Noise Reduction 2D Auto	81 01 04 50 02 ff
Noise Reduction 2D Manual	81 01 04 50 03 ff
Noise Reduction 3D Close	81 01 04 54 00 FF
Noise Reduction 3D Low	81 01 04 54 01 FF
Noise Reduction 3D Middle	81 01 04 54 05 FF
Noise Reduction 3D High	81 01 04 54 09 FF
gamma	81 01 04 5B 06 FF
Flicker Reduction OFF	81 01 04 23 00 FF
Flicker Reduction 50Hz	81 01 04 23 01 FF
Flicker Reduction 60Hz	81 01 04 23 02 FF
Aperture Reset	81 01 04 02 00 FF
Aperture Up	81 01 04 02 02 FF
Aperture Down	81 01 04 02 03 FF
Aperture To Min	81 01 04 42 00 00 00 00 FF
Aperture To Max	81 01 04 42 00 00 00 0F FF
B/W mode off	81 01 04 63 00 FF
B/W mode on	81 01 04 63 04 FF
memory reset	81 01 04 3F 00 05 FF
set	81 01 04 3F 01 05 FF
recall	81 01 04 3F 02 05 FF
Clear all presets	81 0A 11 26 00 FF
Flip Horizontal On	81 01 04 61 02 FF



Flip Horizontal off	81 01 04 61 03 FF
Flip Vertical On	81 01 04 66 02 FF
Flip Vertical Off	81 01 04 66 03 FF
Color Gain 60%	81 01 04 49 00 00 00 00 FF
Color Gain 100%	81 01 04 49 00 00 00 04 FF
Color Gain 150%	81 01 04 49 00 00 00 09 FF
Color Gain 200%	81 01 04 49 00 00 00 0E FF
IR Remote Control On	81 01 06 08 02 FF
OFF	81 01 06 08 03 FF
hue 0	81 01 04 4F 00 00 00 00 FF
hue 14	81 01 04 4F 00 00 00 0E FF
white balance sensitivity high	81 01 04 A9 00 FF
middle	81 01 04 A9 01 FF
low	81 01 04 A9 02 FF
focus area top	81 01 04 AA 00 FF
Center	81 01 04 AA 01 FF
bottom	81 01 04 AA 02 FF
inversion	81 01 04 A4 03 FF
Flip Vertical only	81 01 04 A4 02 FF
Flip Horizontal only	81 01 04 A4 01 FF
off	81 01 04 A4 00 FF
focus balance sensitivity high	81 01 04 58 01 FF
middle	81 01 04 58 02 FF
low	81 01 04 58 03 FF
Restore default	81 01 04 A0 10 FF
RESET	81 01 06 05 FF
Open menu	81 01 06 06 02 FF
Close menu	81 01 06 06 03 FF
Open/Close menu	81 01 06 06 10 FF
up	81 01 06 01 0E 0E 03 01 FF
down	81 01 06 01 0E 0E 03 02 FF
left	81 01 06 01 0E 0E 01 03 FF
right	81 01 06 01 0E 0E 02 03 FF
confirm	81 01 06 06 05 FF
back	81 01 06 06 04 FF
up	81 01 06 01 18 14 03 01 FF
down	81 01 06 01 18 14 03 02 FF
left	81 01 06 01 18 14 01 03 FF
right	81 01 06 01 18 14 02 03 FF
up left	81 01 06 01 18 14 01 01 FF
up right	81 01 06 01 18 14 02 01 FF
down left	81 01 06 01 18 14 01 02 FF
down right	81 01 06 01 18 14 02 02 FF

stop	81 01 06 01 00 00 03 03 FF
St. Limit LeftUp	81 01 06 02 18 14 00 00 00 00 0F 0F 0F FF
St. Limit LeftDown	81 01 06 02 18 14 00 00 00 00 00 00 00 FF
St. Limit RightUp	81 01 06 02 18 14 05 00 00 00 00 0F 0F 0F FF
St. Limit RightDown	81 01 06 02 18 14 05 00 00 00 00 00 00 FF
AVA. Limit LeftUp	81 01 06 02 18 14 0F 09 00 00 00 03 00 00 FF
AVA. Limit RightUp	81 01 06 02 18 14 00 07 00 00 00 03 00 00 FF
AVA. Limit LeftDown	81 01 06 02 18 14 0F 09 00 00 0F 0D 00 00 FF
AVA. Limit RightDown	81 01 06 02 18 14 00 07 00 00 0F 0D 00 00 FF
Relative Right Up	81 01 06 03 18 14 00 01 00 00 00 01 00 00 FF
Relative Left Down	81 01 06 03 18 14 0F 0F 00 00 0F 0F 00 00 FF
Relative Up	81 01 06 03 18 14 00 00 00 00 00 01 00 00 FF
Relative Down	81 01 06 03 18 14 00 00 00 00 0F 0F 00 00 FF
Relative Left	81 01 06 03 18 14 0F 0F 00 00 00 00 00 00 FF
Relative Right	81 01 06 03 18 14 00 01 00 00 00 00 00 00 FF
LimitSet	81 01 06 07 00 00 00 03 00 00 0F 04 00 00 FF
LimitSet	81 01 06 07 00 01 00 03 00 00 0F 04 00 00 FF
LimitClear	81 01 06 07 01 00 07 0F 0F 0F 07 0F 0F 0F FF
LimitClear	81 01 06 07 01 01 07 0F 0F 0F 07 0F 0F 0F FF
HOME	81 01 06 04 FF

## 6.2 AI Protocol List

visca_people_track_en	people tracking, box selection commands	on	81 0a 11 54 02 ff
		off	81 0a 11 54 03 ff
		single box selection	81 0a 11 54 15 ff
		box selection off	81 0a 11 54 16 ff
		auto box selection on	81 0a 11 54 12 ff
		auto box selection off	81 0a 11 54 13 ff
people_track_select	people tracking target selection	left	81 0a 11 a3 02 ff
		right	81 0a 11 a3 03 ff
		ok	81 0a 11 a3 04 ff

## 6.3 Pelco-P Protocol List

Function	Command
move upward	a0 01 00 08 00 30 af 39
move upward downward	a0 01 00 10 00 30 af 21
move to the left	a0 01 00 04 10 00 af 15
move to the right	a0 01 00 02 10 00 af 13
focal length far	a0 01 00 20 00 00 af 21
focal length near	a0 01 00 40 00 00 af 41

focus far	A0 00 01 00 00 00 AF 0E
focus near	A0 00 02 00 00 00 AF 0E
set preset 1	a0 01 00 03 00 01 af 03
load preset 1	a0 01 00 07 00 01 af 07
Delete preset 1	a0 01 00 05 00 01 af 01
AUTO FOCUS	A0 00 00 2B 00 01 AF 05
MANUAL FOCUS	A0 00 00 2B 00 02 AF 26
Aperture +	A0 00 04 00 00 00 AF 0B
Aperture -	A0 00 08 00 00 00 AF 07
horizontal position	A0 00 00 51 00 00 AF 5E
vertical position	A0 00 00 53 00 00 AF 5C
Zoom position	A0 00 00 55 00 00 AF 5A

## 6.4 Pelco-D Protocol List

Function	Command
move upward	ff 01 00 08 00 ff 08
move upward downward	ff 01 00 10 00 ff 10
move to the left	ff 01 00 04 ff 00 04
move to the right	ff 01 00 02 ff 00 02
focal length far	ff 01 00 40 00 00 41
focal length near	ff 01 00 20 00 00 21
focus far	FF 01 00 80 00 00 81
focus near	FF 01 01 00 00 00 01
set preset 1	ff 01 00 03 00 01 05
load preset 1	ff 01 00 07 00 01 09
Delete preset 1	ff 01 00 05 00 01 07
AUTO FOCUS	FF 01 00 2B 00 01 2D
MANUAL FOCUS	FF 01 00 2B 00 02 2E
Aperture +	FF 01 02 00 00 00 04
Aperture -	FF 01 04 00 00 00 06
horizontal position	FF 01 00 51 00 00 52
vertical position	FF 01 00 53 00 00 54
Zoom position	FF 01 00 55 00 00 56

## 6.5 Terms & Definitions

● **RCA:** Connector used primarily in consumer AV equipment for both audio and video. The RCA connector was developed by the Radio Corporation of America.

● **BNC:** Stands for Bayonet Neill-Concelman. A cable connector used extensively in television (named for its inventors). A cylindrical bayonet connector that operates with a twist-locking motion.

---

●**CVBS:** CVBS or Composite video, is an analog video signal without audio. Most commonly CVBS is used for transmission of standard definition signals. In consumer applications the connector is typically RCA type, while in professional applications the connector is BNC type.

●**YPbPr:** Used to describe the colour space for progressive-scan. Otherwise known as component video.

●**VGA:** Video Graphics Array. VGA is an analog signal typically used on earlier computers. The signal is non-interlaced in modes 1, 2, and 3 and interlaced when using in mode.

●**DVI:** Digital Visual Interface. The digital video connectivity standard that was developed by DDWG (Digital Display Work Group). This connection standard offers two different connectors: one with 24 pins that handles digital video signals only, and one with 29 pins that handles both digital and analog video.

●**SDI:** Serial Digital Interface. Standard definition video is carried on this 270 Mbps data transfer rate. Video pixels are characterized with a 10-bit depth and 4:2:2 color quantization. Ancillary data is included on this interface and typically includes audio or other metadata. Up to sixteen audio channels can be transmitted. Audio is organised into blocks of 4 stereo pairs. Connector is BNC.

●**HD-SDI:** High-definition serial digital interface (HD-SDI), is standardized in SMPTE 292M this provides a nominal data rate of 1.485 Gbit/s.

● **12G-SDI:** Standardized in SMPTE 424M, consists of a single 2.970 Gbit/s serial link that allows replacing dual link HD-SDI.

●**6G-SDI:** Standardized in SMPTE ST-2081 released in 2015, 6Gbit/s bitrate and able to support 2160p@30.

●**12G-SDI:** Standardized in SMPTE ST-2082 released in 2015, 12Gbit/s bitrate and able to support 2160p@60.

●**U-SDI:** Technology for transmitting large-volume 8K signals over a single cable. a signal interface called the ultra high definition signal/data interface (U-SDI) for transmitting 4K and 8K signals using a single optical cable. The interface was standardized as the SMPTE ST 2036-4.

●**HDMI:** High Definition Multimedia Interface: An interface used for the transmission of uncompressed high definition video, up to 8 channels of audio, and control signals, over a single cable.

●**HDMI 1.3:** released on June 22 2006, and increased the maximum TMDS clock to 340 MHz (10.2 Gbit/s). Support resolution 1920 × 1080 at 120 Hz or 2560 × 1440 at 60 Hz). It added support for 10 bpc, 12 bpc, and 16 bpc color depth (30, 36, and 48 bit/px), called deep color.

●**HDMI 1.4 :** released on June 5, 2009, added support for 4096 × 2160 at 24 Hz, 3840 × 2160 at 24, 25, and 30 Hz, and 1920 × 1080 at 120 Hz. Compared to HDMI 1.3, 3 more features added which are HDMI Ethernet Channel (HEC) , audio return channel (ARC),3D Over HDMI, a new Micro HDMI Connector, an expanded set of color spaces.

●**HDMI 2.0:** Released on September 4, 2013 increases the maximum bandwidth to 18.0 Gbit/s. Other features of HDMI 2.0 include up to 32 audio channels, up to 1536 kHz audio sample frequency, the HE-AAC and DRA audio standards, improved 3D capability, and additional CEC functions.

- 
- **HDMI 2.0a:** Was released on April 8, 2015, and added support for High Dynamic Range (HDR) video with static metadata.
  - **HDMI 2.0b:** Was released March, 2016, support for HDR Video transport and extends the static metadata signaling to include Hybrid Log-Gamma (HLG).
  - **HDMI 2.1:** Released on November 28, 2017. It adds support for higher resolutions and higher refresh rates, Dynamic HDR including 4K 120 Hz and 8K 120 Hz.
  - **DisplayPort:** A VESA standard interface primarily for video, but also for audio, USB and other data. DisplayPort (orDP) is backwards compatible with HDMI, DVI and VGA.
  - **DP 1.1:** Was ratified on 2 April 2007, and version 1.1a was ratified on 11 January 2008. DisplayPort 1.1 allow a maximum bandwidth of 10.8 Gbit/s (8.64 Gbit/s data rate) over a standard 4-lane main link, enough to support 1920x1080@60Hz.
  - **DP 1.2:** Introduced on 7 January 2010, effective bandwidth to 17.28 Gbit/s support increased resolutions, higher refresh rates, and greater color depth, maximum resolution 3840 × 2160@60Hz.
  - **DP 1.4:** Publish on 1 Mar, 2016. overall transmission bandwidth 32.4 Gbit/s ,DisplayPort 1.4 adds support for Display Stream Compression 1.2 (DSC), DSC is a "visually lossless" encoding technique with up to a 3:1 compression ratio. Using DSC with HBR3 transmission rates, DisplayPort 1.4 can support 8K UHD (7680 × 4320) at 60 Hz or 4K UHD (3840 × 2160) at 120 Hz with 30 bit/px RGB color and HDR. 4K at 60 Hz 30 bit/px RGB/HDR can be achieved without the need for DSC.
  - **Multi-mode Fiber:** Fibers that support many propagation paths or transverse modes are called multi-mode fibers, generally have a wider core diameter and are used for short-distance communication links and for applications where high power must be transmitted.
  - **Single-mode Fiber:** Fiber that support a single mode are called single-mode fibers. Single-mode fibers are used for most communication links longer than 1,000 meters (3,300 ft).
  - **SFP:** Small form-factor pluggable, is a compact, hot-pluggable network interface module used for both telecommunication and data communications applications.
  - **Optical Fiber Connector:** Terminates the end of an optical fiber, and enables quicker connection and disconnection than splicing. The connectors mechanically couple and align the cores of fibers so light can pass. 4 most common types of optical fiber connectors are SC, FC, LC,ST.
  - **SC:** (Subscriber Connector), also known as the square connector was also created by the Japanese company – Nippon Telegraph and Telephone. SC is a push-pull coupling type of connector and has a 2.5mm diameter. Nowadays, it is used mostly in single mode fiber optic patch cords, analog, GBIC, and CATV. SC is one of the most popular options, as its simplicity in design comes along with great durability and affordable prices.
  - **LC:** (Lucent Connector) is a small factor connector (uses only a 1.25mm ferrule diameter) that has a snap coupling

mechanism. Because of its small dimensions, it is the perfect fit for high-density connections, XFP, SFP, and SFP+ transceivers.

- FC:** (Ferrule Connector) is a screw type connector with a 2.5mm ferrule. FC is a round shaped threaded fiber optic connector, mostly used on Datacom, telecom, measurement equipment, single-mode laser.

- ST:** (Straight Tip) was invented by AT&T and uses a bayonet mount along with a long spring-loaded ferrule to support the fiber.









- USB:** Universal Serial Bus is a standard that was developed in the mid-1990s that defines cables, connectors and communication protocols. This technology is designed to allow a connection, communication and power supply for peripheral devices and computers.

- USB 1.1:** Full-Bandwidth USB, specification was the first release to be widely adopted by the consumer market. This specification allowed for a maximum bandwidth of 12Mbps.

- USB 2.0:** Or Hi-Speed USB, specification made many improvements over USB 1.1. The main improvement was an increase in bandwidth to a maximum of 480Mbps.

- USB 3.2:** Super Speed USB with 3 varieties of 3.2 Gen 1(original name USB 3.0), 3.2Gen 2(original name USB 3.1), 3.2 Gen 2x2 (original name USB 3.2) with speed up to 5Gbps,10Gbps,20Gbps respectively.

USB version and connectors figure:

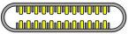
	Type A	Type B	Mini A	Mini B	Micro-A	Micro-B	Type C
● <b>NTSC:</b> The colour video							
							
							

standard used in North America and some other parts of the world created by the National Television Standards Committee in the 1950s. NTSC utilizes an interlaced video signals.

- PAL:** Phase Alternate Line. A television standard in which the phase of the colour carrier is alternated from line to line. It takes four full images (8 fields) for the colour-to-horizontal images (8 fields) for the colour-to-horizontal phase relationship to return to the reference point. This alternation helps cancel out phase errors. For this reason, the hue control is not needed on a PAL TV set. PAL, is widely used in Western Europe, Australia, Africa, the Middle East, and Micronesia. PAL uses 625-line, 50-field (25 fps) composite colour transmission system.

- SMPTE:** Society of Motion image and Television Engineers. A global organization, based in the United States, that sets standards for baseband visual communications. This includes film as well as video and television standards.

- 
- **VESA:** Video Electronics Standards Association. An organization facilitating computer graphics through standards.
  - **HDCP:** High-bandwidth Digital Content Protection (HDCP) was developed by Intel Corporation and is in wide use for protection of video during transmission between devices.
  - **HDBaseT:** A video standard for the transmission of uncompressed video (HDMI signals) and related features using Cat 5e/Cat6 cabling infrastructure.
  - **ST2110:** A SMPTE developed standard, ST2110 describes how to send digital video over and IP networks. Video is transmitted uncompressed with audio and other data in a separate streams. SMPTE2110 is intended principally for broadcast production and distribution facilities where quality and flexibility are more important.
  - **SDVoE:** Software Defined Video over Ethernet (SDVoE) is a method for transmission, distribution and management AV signals using a TCP/IP Ethernet infrastructure for transport with low latency. SDVoE is commonly used in integration applications.
  - **Dante AV:** The Dante protocol was developed for and widely adopted in audio systems for the transmission of uncompressed digital audio on IP based networks. The more recent Dante AV specification includes support for digital video.
  - **NDI:** Network Device interface (NDI) is a software standard developed by NewTek to enable video-compatible products to communicate, deliver, and receive broadcast quality video in a high quality, low latency manner that is frame-accurate and suitable for switching in a live production environment over TCP (UDP) Ethernet based networks. NDI is commonly found in broadcast applications.
  - **RTMP:** Real-Time Messaging Protocol (RTMP) was initially a proprietary protocol developed by Macromedia (now Adobe) for streaming audio, video and data over the Internet, between a Flash player and a server.
  - **RTSP:** The Real Time Streaming Protocol (RTSP) is a network control protocol designed for use in entertainment and communications systems to control streaming media servers. The protocol is used for establishing and controlling media sessions between end points.
  - **MPEG:** Moving Picture Experts Group is a working group formed from ISO and IEC developing standards that allow audio/video digital compression and Transmission.
  - **H.264:** Also known as AVC (Advanced Video Coding) or MPEG-4i is a common video compression standard. H.264 was standardized by the ITU-T Video Coding Experts Group (VCEG) together with the ISO/IEC JTC1 Moving Picture Experts Group (MPEG).
  - **H.265:** Also known as **HEVC** (High Efficiency Video Coding) H.265 is the successor to the widely used H.264/AVC digital video coding standard. Developed under the auspices of ITU, resolutions up to 8192x4320 may be compressed.

- 
- **API:** An Application Programming Interface (API) provides a predefined function which allows access capabilities and features or routines via a software or hardware, without accessing source code or understanding the details of inner working mechanism. An API call may execute a function and/or provide data feedback/report.
  - **DMX512:** The communication standard developed by USITT for entertainment and digital lighting systems. The wide adoption of the Digital Multiplex (DMX) protocol has seen the protocol used for a wide range of other devices including video controllers. DMX512 is delivered over cable of 2 twisted pairs with 5pin XLR cables for connection.
  - **ArtNet:** An ethernet protocol based on TCP/IP protocol stack, mainly used in entertainment/events applications. Built on the DMX512 data format, ArtNet enables multiple “universes” of DMX512 to be transmitted using ethernet networks for transport.
  - **MIDI:** MIDI is the abbreviation of Musical Instrument Digital Interface. As the name indicates the protocol was developed for communication between electronic musical instruments and latterly computers. MIDI instructions are triggers or commands sent over twisted pair cables, typically using 5pin DIN connectors.
  - **OSC:** The principle of Open Sound Control (OSC) protocol is for networking sound synthesizers, computers, and multimedia devices for musical performance or show control. As with XML and JSON, the OSC protocol allows sharing data. OSC is transported via UDP packets between devices connected on an Ethernet.
  - **Brightness:** Usually refers to the amount or intensity of video light produced on a screen without regard to colour. Sometimes called black level.
  - **Contrast Ratio:** The ratio of the high light output level divided by the low light output level. In theory, the contrast ratio of the television system should be at least 100:1, if not 300:1. In reality, there are several limitations. Well-controlled viewing conditions should yield a practical contrast ratio of 30:1 to 50:1.
  - **Colour Temperature:** The colour quality, expressed in degrees Kelvin (K), of a light source. The higher the colour temperature, the bluer the light. The lower the temperature, the redder the light. Benchmark colour temperature for the A/V industry include 5000°K, 6500°K, and 9000°K.
  - **Saturation:** Chroma, Chroma gain. The intensity of the colour, or the extent to which a given colour in any image is free from white. The less white in a colour, the truer the colour or the greater its saturation. Saturation is the amount of pigment in a colour, and not the intensity.
  - **Gamma:** The light output of a CRT is not linear with respect to the voltage input. The difference between what you should have and what is actually output is known as gamma.
  - **Frame:** In interlaced video, a frame is one complete image. A video frame is made up of two fields, or two sets of interlaced lines. In a film, a frame is one still image of a series that makes up a motion image.
  - **Genlock:** Allows synchronisation of otherwise video devices. A signal generator provides a signal pulses which connected devices can reference. Also see Black Burst and Color Burst.



---

● **Blackburst:** The video waveform without the video elements. It includes the vertical sync, horizontal sync, and the Chroma burst information. Blackburst is used to synchronize video equipment to align the video output.

● **Colour Burst:** In colour TV systems, a burst of subcarrier frequency located on the back part of the composite video signal. This serves as a colour synchronizing signal to establish a frequency and phase reference for the Chroma signal. Colour burst is 3.58 MHz for NTSC and 4.43 MHz for PAL.

● **Colour Bars:** A standard test pattern of several basic colours (white, yellow, cyan, green, magenta, red, blue, and black) as a reference for system alignment and testing. In NTSC video, the most commonly used colour bars are the SMPTE standard colour bars. In PAL video, the most commonly used colour bars are eight full field bars. On computer monitors the most commonly used colour bars are two rows of reversed colour bars.

● **Seamless Switching:** A feature found on many video switchers. This feature causes the switcher to wait until the vertical interval to switch. This avoids a glitch (temporary scrambling) which often is seen when switching between sources.

● **Scaling:** A conversion of a video or computer graphic signal from a starting resolution to a new resolution. Scaling from one resolution to another is typically done to optimize the signal for input to an image processor, transmission path or to improve its quality when presented on a particular display.

● **PIP:** Picture-In-Picture. A small image within a larger image created by scaling down one of the images to make it smaller. Other forms of PIP displays include Picture-By-Picture (PBP) and Picture-With-Picture (PWP), which are commonly used with 16:9 aspect display devices. PBP and PWP image formats require a separate scaler for each video window.

● **HDR:** is a high dynamic range (HDR) technique used in imaging and photography to reproduce a greater dynamic range of luminosity than what is possible with standard digital imaging or photographic techniques. The aim is to present a similar range of luminance to that experienced through the human visual system.

● **UHD:** Standing for Ultra High Definition and comprising 4K and 8K television standards with a 16:9 ratio, UHD follows the 2K HDTV standard. A UHD 4K display has a physical resolution of 3840x2160 which is four times the area and twice both the width and height of a HDTV/Full HD (1920x1080) video signal.

● **EDID:** Extended Display Identification Data. EDID is a data structure used to communicate video display information, including native resolution and vertical interval refresh rate requirements, to a source device. The source device will then output the provided EDID data, ensuring proper video image quality.

---

## 6.6 Revision History

The table below lists the changes to the User Manual.

Version	Date	ECO#	Description	Editor
V1.0	2023-12-22	0000#	First release	Aster
V1.1	2024-03-26	0001#	Add White PTZ models	Aster
V1.2	2024-04-22	0002#	Add command protocols	Aster

All information herein is Xiamen RGBlink Science & Technology Co Ltd. excepting noted. **RGBlink** is a registered trademark of Xiamen RGBlink Science & Technology Co Ltd.

While all efforts are made for accuracy at time of printing, we reserve the right to alter otherwise make change without notice.